

IKA®

Product Overview 2015



designed
to work perfectly

Welcome to the IKA® group

IKA®-Werke GmbH & Co. KG in Staufen, Germany can now look back on a century of history.

The company, which was founded in 1910 as a distributor for pharmacies and hospitals, relocated from bombed-out Cologne to Staufen in 1942. There it quickly became the global market leader for laboratory technology as well as dispersing, stirring, and kneading instruments. Today, IKA® employs over 800 people at eight different locations on four continents.

IKA® laboratory technology offers a vast spectrum of innovative devices for numerous applications in research and development. For mixing, tempering, distilling or crushing, market leaders in varying fields of application rely on IKA®'s innovative and proven technology.

For more information, please visit:
www.ika.com

The cover of this brochure is a collection of images of our IKAworldwide instagram followers. We would like to say Thank You to all of them.



IKAworldwide | #lookattheblue

Mixing

Magnetic Stirrers	Page 4
Overhead Stirrers	Page 28
Shakers	Page 42

Crushing

Dispersers	Page 62
Mills	Page 86

Heating / Tempering

Dry Block Heaters	Page 98
Hotplates	Page 104
Temperature control	Page 108

Separation

Centrifuge	Page 118
Rotary Evaporators	Page 120

Laboratory Reactors

Packages	Page 134
----------	----------

Analytical Technology

Calorimeters	Page 148
--------------	----------

Software

labworldsoft®	Page 144
CalWin	Page 144

Packages	Page 158
----------	----------

Mixing

Magnetic Stirrers



Overhead Stirrers



Shakers



Crushing

Dispersers



Mills



Heating / Tempering

Dry Block Heaters



Hotplates



Temperature control



Separation

Centrifuge



Rotary Evaporators



Laboratory Reactors



Analytical Technology

Calorimeters



Software

labworldsoft® / CalWin



Magnetic stirrers



IKA® magnetic stirrers are made for Scientists. When a product is developed, the engineers focus on safety, power and intelligence. There is a complete range of magnetic stirrers to handle various tasks, applications and quantities, either with or without heating capabilities and with open or closed vessels. IKA® stirrers require up to 25% less energy than other manufacturer's products.



Patented

RET® control-visc with white coated heating plate!

- > Offers excellent chemical resistance
- > Easy to clean

RET® control-visc



Integrated temperature sensor for precise temperature control



Integrated weighing function allows the user to measure weight changes of up to 5,000 g



Torque trend measurement
Viscosity changes in the medium can be measured by using a torque measurement device. The results can be depicted on the display



RS 232 interface for PC connection



USB interface to control and document all parameters using labworldsoft® software and for updating your firmware



Magnetic stirrers with heating



RH basic / digital with white coated heating plate!

- > Offers excellent chemical resistance
- > Easy to clean



Best-seller!



Watch the video:
www.ika.com/video



Technical data	RH basic 2	RH basic RH basic white	RH digital RH digital white
Max. stirring quantity (H ₂ O)	10 l	15 l	15 l
Motor rating input / output	15 W	20 / 2 W	20 / 2 W
Speed range	100 – 2000 rpm	100 – 2000 rpm	100 – 2000 rpm
Speed display	scale (0 – 6)	scale	LED
Heat output	400 W	600 W	600 W
Temperature range	RT – 320 °C	50 – 320 °C	50 – 320 °C
Max. magnetic bar (L x Ø)	–	80 mm	80 mm
Safety circuit	400 °C	100 – 360 °C	100 – 360 °C
Control accuracy with sensor	–	ETS-D5: ± 0.5 K ETS-D6: ± 0.2 K	ETS-D5: ± 0.5 K ETS-D6: ± 0.2 K
Heating plate material	stainless steel (AISI 304)	stainless steel 1.4301 white ceramic	stainless steel 1.4301 white ceramic
Dimensions	Ø 125 mm	Ø 135 mm	Ø 135 mm
Weight	2.4 kg	2.8 kg	2.8 kg
	Ident. No. 0003339000	Ident. No. 0005019700 Ident. No. 0005029700	Ident. No. 0005019800 Ident. No. 0004678000

Technical data	RCT basic	RET basic
Max. stirring quantity (H ₂ O)	20 l	20 l
Motor rating input / output	16 / 9 W	16 / 9 W
Speed range	50 – 1500 rpm	50 – 1700 rpm
Heat output	600 W	600 W
Temperature range	RT – 310 °C	RT – 340 °C
Adjustable safety circuit	50 – 360 °C	50 – 360 °C
Control accuracy with sensor	PT 1000: ± 1 K ETS-D5: ± 0.5 K ETS-D6: ± 0.2 K	PT 1000: ± 1 K ETS-D5: ± 0.5 K ETS-D6: ± 0.2 K
Heating plate material	aluminum alloy	stainless steel
Heating plate dimensions	Ø 135 mm	Ø 135 mm
Dimensions (W x D x H)	160 x 270 x 85 mm	160 x 270 x 95 mm
Weight	2.5 kg	2.5 kg
	Ident. No. 0003810000*	Ident. No. 0003622000

* PT 1000.60 included in delivery.

Magnetic stirrers with heating

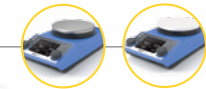

RET® control-visc with white coated heating plate!

- > Offers excellent chemical resistance
- > Easy to clean

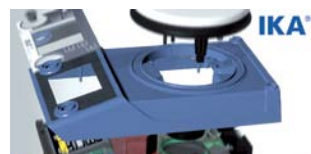

RET® control-visc

Watch the video:
www.ika.com/video



Technical data

	RET® control-visc replaces RET control/t	RET® control-visc white replaces RET control/t
Max. stirring quantity (H ₂ O)	20 l	20 l
Motor rating input / output	16 / 9 W	16 / 9 W
Speed range	50 – 1700 rpm	50 – 1700 rpm
Heat output	600 W	600 W
Temperature range	RT – 340 °C	RT – 340 °C
Adjustable safety circuit	50 – 380 °C	50 – 380 °C
Control accuracy with sensor	PT 100: ± 0.2 K	PT 100: ± 0.2 K
Heating plate material	stainless steel 1.4301	white ceramic
Heating plate dimensions	Ø 135 mm	Ø 135 mm
Dimensions (W x D x H)	160 x 270 x 85 mm	160 x 270 x 85 mm
Weight	3 kg	3 kg

Ident. No. 0005020000*

Ident. No. 0005030000*

* PT 100.70 included in delivery



TFT Display
TFT display for better image quality and easy navigation

Extra strong heating
Icon of a heating plate with wavy lines and a temperature symbol.

Integrated temperature sensor
Icon of a temperature probe with a temperature symbol.

RET® control-visc
Ncm %
Torque trend measurement
Viscosity changes in the medium can be measured by using a torque measurement device. The results can be depicted on the display

Patented

Integrated weighing function allows the user to measure weight changes of up to 5,000 g

USB interface to control and document all parameters using labworldsoft® software and for updating your firmware



The Magnetic Stirrer for Scientists
Strongest and safest magnetic stirrer in its class with integrated patented weighing function and high sensitive torque trend indication

Magnetic stirrers with heating



C-MAG HS 7



DIN Bushing 12878 for connecting an electronic contact thermometer



Elevated control panel for protection against spilled liquids



Hot Top indicator to prevent burns



Ceramic set-up plate offers excellent chemical resistance to acid, bases and solvents

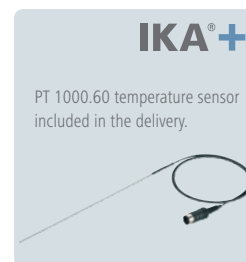

Elevated control panel for protection against spilled liquids



LCD display for simultaneous display of target and actual temperatures



Ceramic set-up plate offers excellent chemical resistance to acid, bases and solvents

C-MAG HS 7 digital



Hot Top indicator to prevent burns



Integrated temperature sensor for precise temperature control



Technical data	C-MAG HS 4	C-MAG HS 7	C-MAG HS 10
Max. stirring quantity (H ₂ O)	5 l	10 l	15 l
Motor rating input / output	15 / 1.5 W	15 / 1.5 W	15 / 1.5 W
Speed range	100 – 1500 rpm	100 – 1500 rpm	100 – 1500 rpm
Heat output	250 W	1000 W	1500 W
Temperature range	50 – 500 °C	50 – 500 °C	50 – 500 °C
Display	LED	LED	LED
Max. stirring bar length	30 mm	80 mm	80 mm
Safety circuit	550 °C (fixed)	550 °C (fixed)	550 °C (fixed)
Control accuracy with sensor	–	ETS-D5 / ± 0.5 K	ETS-D5 / ± 0.5 K
Heating plate material	ceramic	ceramic	ceramic
Set-up plate dimensions	100 x 100 mm	180 x 180 mm	260 x 260 mm
Weight	3 kg	5 kg	6 kg
	Ident. No. 0003581000	Ident. No. 0003581200 C-MAG HS 7 Package Ident. No. 0009015900	Ident. No. 0003581400

Technical data	C-MAG HS 4 digital	C-MAG HS 7 digital	C-MAG HS 10 digital
Max. stirring quantity (H ₂ O)	5 l	10 l	15 l
Motor rating input / output	15 / 1.5 W	15 / 1.5 W	15 / 1.5 W
Speed range	100 – 1500 rpm	100 – 1500 rpm	100 – 1500 rpm
Heat output	250 W	1000 W	1500 W
Temperature range	50 – 500 °C	50 – 500 °C	50 – 500 °C
Display	LCD	LCD	LCD
Max. stirring bar length	30 mm	80 mm	80 mm
Adjustable safety circuit	550 °C (fixed)	550 °C (fixed)	550 °C (fixed)
Control accuracy with sensor	± 0.5 K	± 0.5 K	± 0.5 K
Heating plate material	ceramic	ceramic	ceramic
Set-up plate dimensions	100 x 100 mm	180 x 180 mm	260 x 260 mm
Weight	3 kg	5 kg	6 kg
	Ident. No. 0004240200*	Ident. No. 0003487000*	Ident. No. 0004240400*

* PT 1000.60 included in delivery

Package details
on page 158

Multiposition stirrers with / without heating

RT 15



Heating foil for homogeneous temperature distribution of the heating plate



Reverse rotation switch for better mixing results



Wear-free magnetic coils for consistent and silent operation



	RT 5	RT 10	RT 15
Technical data	replaces RT 5 power	replaces RT 10 power	replaces RT 15 power
Number of stirring positions	5	10	15
Max. stirring quantity (H ₂ O)	0.4 l	0.4 l	0.4 l
Distance between stirring places	90 mm	90 mm	90 mm
Deviation for individual stirring positions	0%	0%	0%
Speed display	LED	LED	LED
Speed range	0 – 1000 rpm	0 – 1000 rpm	0 – 1000 rpm
Speed adjustment	10 rpm steps	10 rpm steps	10 rpm steps
Heat output	175 W	375 W	580 W
Temperature range heating plate	RT – 120 °C	RT – 120 °C	RT – 120 °C
Max. temperature medium (dep. on vessel)	70 °C	70 °C	70 °C
Set-up plate material	aluminum alloy	aluminum alloy	aluminum alloy
Set-up plate dimensions	110 x 495 mm	180 x 495 mm	270 x 495 mm
Dimensions (W x D x H)	120 x 610 x 60 mm	190 x 610 x 60 mm	280 x 610 x 60 mm
Weight	4 kg	7.5 kg	10.5 kg
	Ident. No. 0003690600	Ident. No. 0003691100	Ident. No. 0003692600



	RO 5	RO 10	RO 15
Technical data			
Number of stirring positions	5	10	15
Max. stirring quantity (H ₂ O)	0.4 l	0.4 l	0.4 l
Distance between stirring places	90 mm	90 mm	90 mm
Deviation for individual stirring positions	0%	0%	0%
Speed display	LED	LED	LED
Speed range	0 – 1200 rpm	0 – 1200 rpm	0 – 1200 rpm
Speed adjustment	10 rpm steps	10 rpm steps	10 rpm steps
Set-up plate material	stainless steel 1.4301	stainless steel 1.4301	stainless steel 1.4301
Set-up plate dimensions	120 x 470 mm	190 x 470 mm	280 x 470 mm
Dimensions (W x D x H)	120 x 570 x 60 mm	190 x 570 x 60 mm	280 x 570 x 60 mm
Weight	3 kg	5 kg	7 kg
	Ident. No. 0003690500	Ident. No. 0003691000	Ident. No. 0003692500

Magnetic stirrers without heating

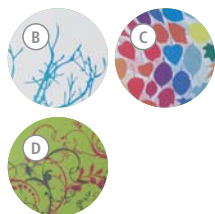
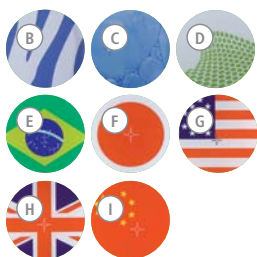

Technical data

	color squid	big squid
Max. stirring quantity (H ₂ O)	1 l	1.5 l
Motor rating input / output	3 / 2 W	3 / 2 W
Speed range	0 – 2500 rpm	0 – 2500 rpm
Speed display	LED	LED
Max. stirring bar length	30 mm	30 mm
Speed adjustment	50 rpm steps	50 rpm steps
Set-up plate material	glass	glass
Set-up plate dimensions	Ø 115 mm	Ø 160 mm
Dimensions (W x D x H)	145 x 160 x 45 mm	180 x 195 x 40 mm
Weight	0.54 kg	0.7 kg
Permissible ambient temperature	5 – 40 °C	5 – 40 °C
Permissible relative moisture	80%	80%
Protection class acc. to DIN EN 60529	IP 54	IP 54
Voltage	100 – 240 V	100 – 240 V
Frequency	50/60 Hz	50/60 Hz

- A Ident. No. 0003671000 white
- B Ident. No. 0003698200 zebra
- C Ident. No. 0003698300 bubbles
- D Ident. No. 0003698400 wave
- E Ident. No. 0004175500 seleção
- F Ident. No. 0004175300 solar sphere
- G Ident. No. 0004175100 stars and stripes
- H Ident. No. 0004175200 union Jack
- I Ident. No. 0004175400 red flag

- A Ident. No. 0003672000 white
- B Ident. No. 0003857200 frozen
- C Ident. No. 0003857100 leaves
- D Ident. No. 0003857300 twist



Electronically controlled, high power motor for a higher capacity and higher speed range



Glass plate for excellent chemical resistance to acids, bases and solvents



The digital display enables precise setting of speed



color squid

color squid

- > For maximum stirring quantity of 1 l (H₂O)
- > Available in various interesting motives

big squid

- > For maximum stirring quantity of 1.5 l (H₂O)
- > Higher speed range from 0 – 2500 rpm



IKA® +

The difference between the color squid and the big squid is the **set-up plate diameter**.

color squid: Ø 115 mm
big squid: Ø 160 mm



Magnetic stirrers without heating



IKA®+

Mobile unit with rechargeable batteries with long operating time (8 – 12 h)



Technical data	Mini MR standard	topolino	topolino mobil
Max. stirring quantity (H ₂ O)	1 l	0.25 l	0.25 l
Motor rating input / output	3 / 2 W	1 / 0.8 W	1 / 0.8 W
Speed range	0 – 2500 rpm	300 – 1800 rpm	300 – 1800 rpm
Max. stirring bar length	30 mm	30 mm	30 mm
Speed adjustment	–	stepless	stepless
Set-up plate material	polyester	synthetic (PP)	synthetic (PP)
Set-up plate dimensions	115 x 115 mm	Ø 80 mm	Ø 80 mm
Dimensions (W x D x H)	114 x 127 x 37 mm	95 x 115 x 37 mm	Ø 140 x 42 mm
Weight	0.25 kg	0.32 kg	0.60 kg
Permissible ambient temperature	5 – 40 °C	5 – 40 °C	5 – 40 °C
Permissible relative moisture	80%	80%	80%
Protection class acc. to DIN EN 60529	IP 42	IP 21	IP 21
Voltage	100 – 240 V	100 – 240 V	100 – 240 V
Frequency	50/60 Hz	50/60 Hz	50/60 Hz
	Ident. No. 0003674000	Ident. No. 0003368000	Ident. No. 0003381300



Switchable reverse rotation every 30 seconds



Modern wear-free magnetic coil technology



lab disc



Ultra-flat for stirring quantities of up to 800 ml (H₂O)



lab disc

- > Set-up plate and casing made of chemically resistant materials
- > Slip-proof and safe stand

Height only
12mm

(A)

lab disc

Max. stirring quantity	0.8 l
Motor rating input / output	5 / 3 W
Speed range	15 – 1500 rpm
Max. stirring bar length	25 mm
Speed adjustment	stepless
Set-up plate material	polyester
Set-up plate dimensions	Ø 100 mm
Dimensions (W x D x H)	117 x 180 x 12 mm
Weight	0.3 kg
Permissible ambient temperature	5 – 40 °C
Permissible relative moisture	80%
Protection class acc. to DIN EN 60529	IP 65
Voltage	100 – 240 V
Frequency	50/60 Hz



(B)



(C)

- (A) Ident. No. 0003907500 white
- (B) Ident. No. 0003765000 pattern
- (C) Ident. No. 0003916100 stream

Magnetic stirrers without heating

Maxi MR 1 digital



For stirring quantities up to 150 l (H₂O)



Infinitely adjustable speed with digital display



Timer or continuous operation



Technical data	KMO 2 basic	Midi MR 1 digital	Maxi MR 1 digital
Max. stirring quantity (H ₂ O)	5 l	50 l	150 l
Motor rating input / output	14 / 4 W	70 / 19 W	80 / 35 W
Speed range	0 – 1100 rpm	0 – 1000 rpm	0 – 600 rpm
Speed display	scale	LCD	LCD
Max. stirring bar length	50 mm	80 mm	155 mm
Speed adjustment	stepless	stepless	stepless
Heating plate material	stainless steel 1.4301	stainless steel 1.4301	stainless steel 1.4301
Set-up plate dimensions	140 x 120 mm	350 x 350 mm	500 x 500 mm
Dimensions (W x D x H)	140 x 200 x 75 mm	360 x 430 x 110 mm	505 x 585 x 110 mm
Weight	1.4 kg	10.7 kg	16 kg
Permissible ambient temperature	5 – 40 °C	5 – 40 °C	5 – 40 °C
Permissible relative moisture	80%	80%	80%
Protection class acc. to DIN EN 60529	IP 21	IP 21	IP 21
Voltage	230 V	230 V	230 V
Frequency	50/60 Hz	50/60 Hz	50/60 Hz
	Ident. No. 0002812000	Ident. No. 0002621900	Ident. No. 0002621800

C-MAG MS 10



Ceramic set-up plate offers excellent chemical resistance to acid, bases and solvents



Powerful motor for stirring quantities up to 15 l (H₂O)



Elevated control panel for protection against spilled liquids



Technical data	C-MAG MS 4	C-MAG MS 7	C-MAG MS 10
Max. stirring quantity (H ₂ O)	5 l	10 l	15 l
Motor rating input / output	15 / 1.5 W	15 / 1.5 W	15 / 1.5 W
Speed range	100 – 1500 rpm	100 – 1500 rpm	100 – 1500 rpm
Speed display	scale	scale	scale
Max. stirring bar length	30 mm	80 mm	80 mm
Speed adjustment	scale (0 – 6)	scale (0 – 6)	scale (0 – 6)
Heating plate material	ceramic	ceramic	ceramic
Set-up plate dimensions	100 x 100 mm	180 x 180 mm	260 x 260 mm
Dimensions (W x D x H)	150 x 260 x 105 mm	220 x 330 x 105 mm	300 x 415 x 105 mm
Weight	3 kg	5 kg	6 kg
Permissible ambient temperature	5 – 40 °C	5 – 40 °C	5 – 40 °C
Permissible relative moisture	80%	80%	80%
Protection class acc. to DIN EN 60529	IP 21	IP 21	IP 21
Voltage	230 V	230 V	230 V
Frequency	50/60 Hz	50/60 Hz	50/60 Hz
	Ident. No. 0003582200	Ident. No. 0003582400	Ident. No. 0003582600



Magnetic Stirrers | Accessories



Electronic contact thermometers

	Ident. No.
① ETS-D5	0003378000
Electronic contact thermometer, -50 – 450 °C, 0.1 K resolution	
② ETS-D6	0003378100
Electronic contact thermometer. Similar to ETS-D5, additionally comes equipped with integrated pH measuring instrument (without pH electrode)	

Temperature sensors for ETS-D5 / D6

	Ident. No.
③ H 62.51	0002735451
Temperature sensor, stainless steel, Ø 3 mm, 260 mm length	
④ H 66.51	0002735551
Temperature sensor, stainless steel, glass-coated, Ø 6 mm, 260 mm length	
H 66.53	0004499900
Temperature sensor, coated with SafeCoat, Ø 3 mm, 260 mm length	

ETS-D5 / D6 Accessories

	Ident. No.
⑤ H 70	0002735600
Extension cable, 1 m	

Temperature sensors for RCT / RET basic and C-MAG HS digital series

	Ident. No.
⑥ PT 1000.60	0003516800
Temperature sensor, stainless steel, Ø 3 mm, 230 mm length	
⑦ PT 1000.70	0003736000
Temperature sensor, stainless steel, glass-coated, Ø 7 mm, 230 mm length	
⑧ PT 1000.80	0004443000
Temperature sensor, stainless steel, Ø 3 mm, 150 mm length	
PT 1000.90	0004480600
Temperature sensor, stainless steel, coated with SafeCoat, Ø 3 mm, 230 mm length	

Temperature sensors for RET® control-visc

	Ident. No.
PT 100.70	0020000440
Temperature sensor, stainless steel, Ø 3 mm, 230 mm length	
⑨ PT 1000.50	0003367600
Temperature sensor, dual stainless steel, Ø 3 mm, 230 mm length	
⑩ PT 1000.51	0003377700
Temperature sensor, dual stainless steel, glass-coated, Ø 8 mm	
⑪ PT 100.51	0002600300
Temperature sensor, glass-coated, Ø 8 mm, 230 mm length	
PT 100.53	0004499700
Temperature sensor, stainless steel, coated with SafeCoat, Ø 3 mm, 230 mm length	
PT 1000.53	0004499800
Temperature sensor, dual coated with SafeCoat, 230 mm length	

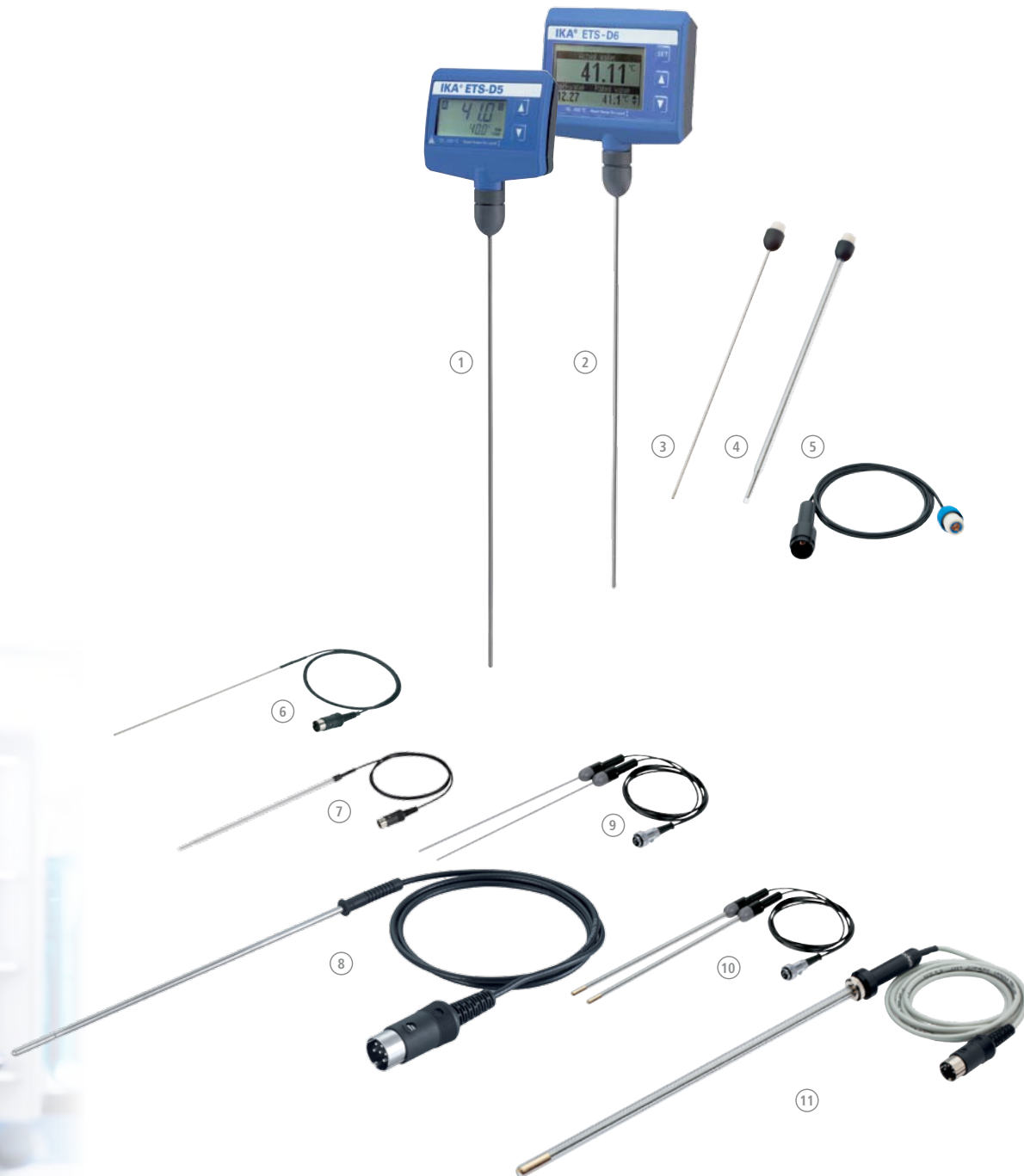

Magnetic Stirrers | Accessories

Advantages beaker, stainless steel

- > No eddy current losses
- > High magnetic adhesion force
- > Very good heat transfer (3 L beaker and up: due to a round deepening area for fitting heating plates with Ø 135 mm)

Oil bath attachments

	Ident. No.
H 29	0002829400
Oil bath attachment, 1 l, aluminum, inner Ø 136 – 180 mm, 81 mm height for use with oil only	
H 30	0002829500
Oil bath attachment, 1.5 l, aluminum, inner Ø 136 – 190 mm, 110 mm height for use with oil only	

Beakers

10	H 1000	000444401	Beaker, stainless steel, 1 l, inner Ø 160 mm, 79 mm height
11	H 1500	0004444501	Beaker, stainless steel, 1.5 l, inner Ø 140 mm, 160 mm height
12	H 3000	0004444503	Beaker, stainless steel, 3 l, inner Ø 180 mm, 119 mm height
13	H 5000	0004444505	Beaker, stainless steel, 5 l, inner Ø 220 mm, 142 mm height
14	H 8000	0004444508	Beaker, stainless steel, 8 l, inner Ø 265 mm, 162 mm height

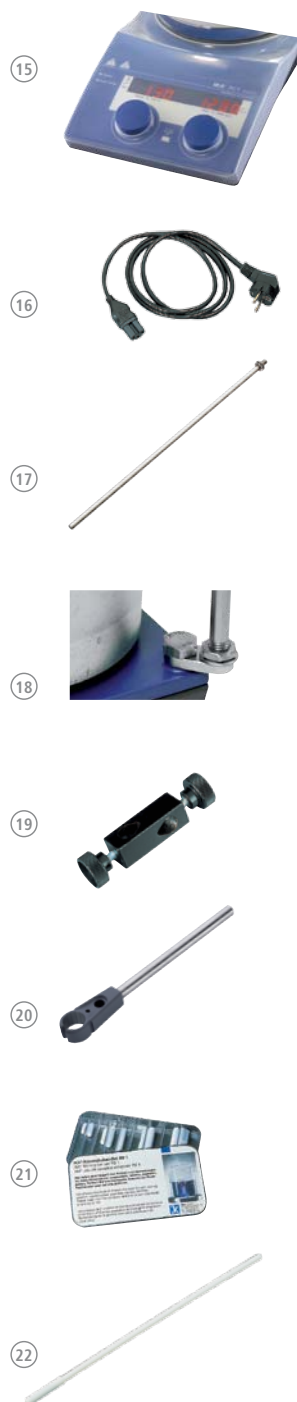

Protective covers

H 102	0004281600
Cover for RH basic	
H 103	0004299100
Cover for RH digital	
15 H 100	0003409600
Cover for RET basic and RCT basic	
H 104	0004209500
Cover for RET® control-visc	

Other accessories

16 H 11 (Euro USA UK CH plug)	0001091500
	0003564500
	0002410700
	0001091600
Mains cable, spare	
17 H 16 V	0001545100
Support rod, Ø 10 mm, 450 mm length	
18 H 16.1	0005000500
Extension for support rod	
19 H 44	0002437700
Boss head clamp	
20 H 38	0003547700
Holding rod	
HG 600	0020003416
Heating jacket for beaker 600 ml	
HG 1000	0020003415
Heating jacket for beaker 1000 ml	
BC 1000	0020003417
Beaker cap	
C-MAG Adapter	0025001022
Heating block adapter for C-MAG	
Stirring bars	
21 RS 1	0001358600
Consisting of IKAFILON® (10 – 80 mm) and TRIKA® (25 and 40 mm) magnetic stirring bars	
RS 2	0004499100
Consisting of IKAFILON® 40 round, 40 glass, 30 power, 40 slide round, 40 ellipse, 40 TRIKA®, 25 cross, 9 crown and 25 bone magnetic stirring bars	
22 RSE	0001293100
Stirring bar remover	

Magnetic Stirrers | Accessories

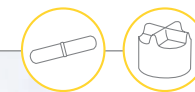

Stirring bars

IKAFLON® round

	Dimensions (L x Ø)	Ident. No.
IKAFLON® 10 Set (5 Pcs) round PTFE-coated	10 x 6 mm	0004488600
IKAFLON® 15 Set (5 Pcs) round PTFE-coated	15 x 6 mm	0004488700
IKAFLON® 20 Set (5 Pcs) round PTFE-coated	20 x 8 mm	0004488800
IKAFLON® 25 Set (5 Pcs) round PTFE-coated	25 x 8 mm	0004488900
IKAFLON® 30 Set (5 Pcs) round PTFE-coated	30 x 8 mm	0004489000
IKAFLON® 40 Set (5 Pcs) round PTFE-coated	40 x 8 mm	0004489100
IKAFLON® 50 Set (5 Pcs) round PTFE-coated	50 x 8 mm	0004489200
IKAFLON® 80 Set (5 Pcs) round PTFE-coated	80 x 10 mm	0004489300
IKAFLON® 110 round PTFE-coated*	108 x 27 mm	0000793300
IKAFLON® 155 round PTFE-coated*	153 x 27 mm	0001129000

* Used for large magnetic stirrers like Maxi MR 1 digital

IKAFLON® glass round

	Dimensions (L x Ø)	Ident. No.
IKAFLON® glass 25 Set (5 Pcs) round	25 x 6 mm	0004492200
IKAFLON® glass 30 Set (5 Pcs) round	30 x 6 mm	0004492400
IKAFLON® glass 40 Set (5 Pcs) round	45 x 8 mm	0004492600
IKAFLON® glass 50 Set (5 Pcs) round	50 x 8 mm	0004492800

IKAFLON® power SmSo

	Dimensions (L x Ø)	Ident. No.
IKAFLON® 20 Set (5 Pcs) power SmSo PTFE-coated	20 x 6 mm	0004493000
IKAFLON® 30 Set (5 Pcs) power SmSo PTFE-coated	30 x 6 mm	0004493200
IKAFLON® 50 Set (5 Pcs) power SmSo PTFE-coated	50 x 8 mm	0004493400

IKAFLON® slide round

	Dimensions (L x Ø)	Ident. No.
IKAFLON® 25 Set (5 Pcs) slide round PTFE-coated	25 x 6 mm	0004493800
IKAFLON® 30 Set (5 Pcs) slide round PTFE-coated	30 x 6 mm	0004494000
IKAFLON® 40 Set (5 Pcs) slide round PTFE-coated	40 x 8 mm	0004494200
IKAFLON® 50 Set (5 Pcs) slide round PTFE-coated	50 x 8 mm	0004494400

IKAFLON® ellipse

	Dimensions (L x Ø)	Ident. No.
IKAFLON® 20 Set (5 Pcs) ellipse PTFE-coated	20 x 10 mm	0004494600
IKAFLON® 25 Set (5 Pcs) ellipse PTFE-coated	25 x 12 mm	0004494800
IKAFLON® 30 Set (5 Pcs) ellipse PTFE-coated	32 x 16 mm	0004495000
IKAFLON® 35 Set (5 Pcs) ellipse PTFE-coated	35 x 15 mm	0004495200
IKAFLON® 40 Set (5 Pcs) ellipse PTFE-coated	40 x 20 mm	0004495400
IKAFLON® 50 Set (5 Pcs) ellipse PTFE-coated	50 x 20 mm	0004495600
IKAFLON® 60 Set (5 Pcs) ellipse PTFE-coated	64 x 20 mm	0004495800
IKAFLON® 70 Set (5 Pcs) ellipse PTFE-coated	70 x 20 mm	0004496000

IKAFLON® cross

	Dimensions (L x Ø)	Ident. No.
IKAFLON® 10 Set (5 Pcs) cross PTFE-coated	10 x 10 mm	0004496200
IKAFLON® 20 Set (5 Pcs) cross PTFE-coated	20 x 20 mm	0004496400
IKAFLON® 25 Set (5 Pcs) cross PTFE-coated	25 x 25 mm	0004496600
IKAFLON® 30 Set (5 Pcs) cross PTFE-coated	30 x 30 mm	0004496800
IKAFLON® 38 Set (5 Pcs) cross PTFE-coated	38 x 38 mm	0004497000

IKAFLON® bone

	Dimensions (L x Ø)	Ident. No.
IKAFLON® 37 Set (5 Pcs) bone PTFE-coated	35 x 8 x 20 mm	0004497200
IKAFLON® 54 Set (5 Pcs) bone PTFE-coated	55 x 8 x 20 mm	0004497400

TRIKA®

	Dimensions (L x Ø)	Ident. No.
TRIKA® 25 Set (5 Pcs) PTFE-coated	25 x 8 mm	0004499300
TRIKA® 35 Set (5 Pcs) PTFE-coated	35 x 9 mm	0004499400
TRIKA® 55 Set (5 Pcs) PTFE-coated	55 x 14 mm	0004499500
TRIKA® 80 Set (5 Pcs) PTFE-coated	80 x 17 mm	0004499600

IKAFLON® beaker

	(Ø x Height in mm, for beaker)	Ident. No.
IKAFLON® 67 beaker PTFE-coated	67 x 21 mm with 50 x 8	0004497600
IKAFLON® 74 beaker PTFE-coated	74 x 29 mm with 60 x 9	0004497800
IKAFLON® 103 beaker PTFE-coated	103 x 32 mm with 80 x 10	0004498000
IKAFLON® 125 beaker PTFE-coated	125 x 48 mm with 106 x 25	0004498200

IKAFLON® crown

	(Ø x Height in mm)	Ident. No.
IKAFLON® 9 Set (5 Pcs) crown PTFE-coated	9 x 6 mm	0004498400

Magnetic Stirrers | Accessories

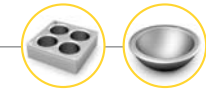

Synthesis blocks

Dry heating block square series

	Hole Ø	Dimensions	Ident. No.
1 H 135.10 Square carrier without handle	–	160 x 160 mm	0025000832
H 135.101 Block 16 x 4 ml	15.2 mm	79 x 79 mm	0025000626
H 135.102 Block 16 x 8 ml	17.5 mm	79 x 79 mm	0025000627
2 H 135.103 Block 9 x 16 ml	20.5 mm	79 x 79 mm	0025000628
3 H 135.104 Block 4 x 20 ml	28.5 mm	79 x 79 mm	0025000629
H 135.105 Block 4 x 30 ml	28.5 mm	79 x 79 mm	0025000630
4 H 135.106 Block 4 x 40 ml	28.5 mm	79 x 79 mm	0025000631
H 135.107 Block 100 ml	–	79 x 79 mm	0025000632
5 H 135.108 Block 250 ml	–	79 x 79 mm	0025000633



100 ml Flask heating block series

	Max. Outer Ø	Inner Ø	Ident. No.
6 H 135.20 Flask carrier 100 ml without handle	142 mm	–	0025000634
H 135.201 Flask inlay 10 ml	–	33.8 mm	0025000636
H 135.202 Flask inlay 25 ml	–	43.8 mm	0025000637
H 135.203 Flask inlay 50 ml	–	52.8 mm	0025000638



500 ml Flask heating block series

	Max. Outer Ø	Inner Ø	Ident. No.
7 H 135.30 Flask carrier 500 ml without handle	142 mm	–	0025000639
H 135.301 Flask inlay 100 ml	–	66.3 mm	0025000641
H 135.302 Flask inlay 250 ml	–	88 mm	0025000642



1000 ml Flask heating block series

	Max. Outer Ø	Inner Ø	Ident. No.
8 H 135.40 Flask carrier 1000 ml without handle	166.3 mm	–	0025000833
9 H 135.401 Flask inlay 500 ml	–	108 mm	0025000644



2000 ml Flask heating block series

	Max. Outer Ø	Inner Ø	Ident. No.
10 H 135.50 Flask carrier 2000 ml without handle	194.7 mm	–	0025000834
H 135.501 Flask inlay 1000 ml	–	131.8 mm	0025000645



3000 ml Flask heating block series

	Max. Outer Ø	Inner Ø	Ident. No.
11 H 135.60 Flask carrier 3000 ml without handle	218.3 mm	–	0025000835
12 H 135.601 Flask inlay 2000 ml	–	162 mm	0025000648



5000 ml Flask heating block series

	Max. Outer Ø	Inner Ø	Ident. No.
13 H 135.70 Flask carrier 5000 ml without handle	259.7 mm	–	0025000836
14 H 135.701 Flask inlay 3000 ml	–	194.5 mm	0025000651

Overhead Stirrers



IKA® offers overhead stirrers for your stirring and mixing tasks in the lab – for low to high viscosities. Safety, power and intelligence were again at the core of the development of this product range.

IKA® overhead stirrers process stirring quantities of up to 200 liters.



The wireless controller

- > Helps protect the user from toxic material exposure
- > Preserving sample integrity



EUROSTAR 100 control

TFT Display

TFT Display for better image quality and easy navigation

External probe

External probe for connection to a temperature sensor for accurate temperature control

USB interface

USB interface to control and document rheological changes and other parameters using labworldsoft® software and for updating your firmware

EC motor

Brushless EC motor for longer life span, low maintenance and higher efficiency

Wireless Controller (WiCo)

Removable wireless controller for easy and user-friendly operation

Electronic Overhead Stirrers



Rotating knob for adjusting the speed and **pressing knob** for navigating through the menu on the wireless controller

Digital display for precise monitoring of set and actual speeds

660 Ncm Torque trend display to get real-time information on viscosity changes

EUROSTAR digital



Technical data

Stirring quantity max. (H₂O)
Max. viscosity
Motor rating input / output
Speed range
Max. torque at stirring shaft
Temp. sensor connection
Chuck range
Dimensions (W x D x H)
Weight
Permissible ambient temp.
Permissible relative moisture
Protection class DIN EN 60529

EUROSTAR 20 digital | 40 digital

replaces RW 14; RW 16; EUROSTAR digital
15 l | 25 l
10,000 mPas | 30,000 mPas
70 / 42 W | 118 / 84 W
0/30 – 2000 rpm
20 Ncm | 40 Ncm
no
0.5 – 10 mm
86 x 208 x 248 mm
4.4 kg
5 – 40 °C
80%
IP 40

Ident. No. 0004442000
Ident. No. 0004444000

EUROSTAR 60 digital | control

replaces EUROSTAR power basic; EUROSTAR power control-visc
40 l
50,000 mPas
176 / 126 W | 168 / 131 W
0/30 – 2000 rpm
60 Ncm
no | PT 1000
0.5 – 10 mm
86 x 208 x 248 mm | 86 x 230 x 267 mm
4.4 kg | 4.7 kg
5 – 40 °C
80%
IP 40

Ident. No. 0004446000
Ident. No. 0004440000*

TFT Display for better image quality and easy navigation

USB interface to control and document rheological changes and other parameters using labworldsoft® software and for updating your firmware

Wireless Controller (WiCo)
Removable wireless controller for easy and user-friendly operation

Brushless EC motor for longer life span, low maintenance and higher efficiency

EUROSTAR control



Technical data

Stirring quantity max. (H₂O)
Max. viscosity
Motor rating input / output
Speed range
Max. torque at stirring shaft
Temp. sensor connection
Chuck range
Dimensions (W x D x H)
Weight
Permissible ambient temp.
Permissible relative moisture
Protection class DIN EN 60529

EUROSTAR 100 digital | control

replaces EUROSTAR control-visc P1
100 l
70,000 mPas
186 / 136 W | 174 / 142 W
0/30 – 1300 rpm
100 Ncm
no | PT 1000
0.5 – 10 mm
86 x 208 x 248 mm | 86 x 230 x 267 mm
4.4 kg | 4.7 kg
5 – 40 °C
80%
IP 40

Ident. No. 0004238100
Ident. No. 0004028500*

EUROSTAR 200 digital | control

replaces EUROSTAR control-visc P4
100 l
100,000 mPas
130 / 84 W
0/6 – 2000 rpm
200 Ncm
no | PT 1000
0.5 – 10 mm
91 x 209 x 274 mm | 91 x 231 x 274 mm
4.6 kg | 4.9 kg
5 – 40 °C
80%
IP 40

Ident. No. 0003990000
Ident. No. 0003992000*

* H 67.60 and WH 11 included in the delivery of all EUROSTAR control devices

Electronic Overhead Stirrers



Watch the video now:
www.ika.com/video



Technical data

Stirring quantity max. (H₂O)

Max. viscosity

Motor rating input / output

Speed range

Max. torque at stirring shaft

Temp. sensor connection

Chuck range

Dimensions (W x D x H)

Weight

Permissible ambient temp.

Permissible relative moisture

Protection class DIN EN 60529

EUROSTAR 200 control P4

replaces EUROSTAR control-visc P7

100 l

150,000 mPas

134 / 76 W

0/4 – 530 rpm

660 Ncm

PT 1000

0.5 – 10 mm

91 x 230 x 379 mm

5.8 kg

5 – 40 °C

80%

IP 40

Ident. No. 0004090000*

EUROSTAR 20 high speed digital | control

replaces EUROSTAR power control-visc 6000

20 l

10,000 mPas

176 / 125 W

0/150 – 6000 rpm

20 Ncm

no | PT 1000

fixed

86 x 208 x 325 mm | 86 x 260 x 344 mm

5.3 kg | 5.6 kg

5 – 40 °C

80%

IP 40

Ident. No. 0004028600

Ident. No. 0025001314*

EUROSTAR 200 control P4



TFT Display for better image quality and easy navigation



Laboratory stirrer designed for highly viscous applications and intensive mixing



Torque trend display to get real-time information on viscosity changes



Extremely powerful laboratory stirrer designed with **high torque**



USB interface to control and document rheological changes and other parameters using labworldsoft® software and for updating your firmware



RS 232 interface for PC connection



Wireless Controller (WiCo) Removable wireless controller for easy and user-friendly operation



* H 67.60 and WH 11 included in the delivery of all EUROSTAR control devices

Mechanical Overhead Stirrers

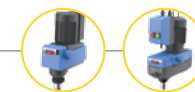

RW 20 digital	
Technical data	
Stirring quantity max. (H ₂ O)	20 l
Max. viscosity	10,000 mPas
Motor rating input/output	70 / 35 W
Permissible ON time	100%
Speed range	60 – 2000 rpm (50 Hz)
Max. torque at stirring shaft	150 Ncm
Display	LED
Temp. sensor connection	no
Chuck range	0.5 – 10 mm
Hollow shaft	yes
Dimensions (W x D x H)	88 x 212 x 294 mm
Weight	3.1 kg
Permissible ambient temp.	5 – 40 °C
Permissible relative moisture	80%
Protection class DIN EN 60529	IP 20

Ident. No. 0003593000

RW 28 digital



Special motor over heating protection



Dual-speed range



RW 28 digital		RW 47 digital	
	replaces RW 28 basic		replaces RW 47 D
Stirring quantity max. (H ₂ O)	80 l	Stirring quantity max. (H ₂ O)	200 l
Max. viscosity	50,000 mPas	Max. viscosity	100,000 mPas
Motor rating input/output	220 / 90 W	Motor rating input/output	513 / 370 W
Permissible ON time	100%	Permissible ON time	100%
Speed range	60 – 1400 rpm (50 Hz)	Speed range	57 – 1300 rpm (50 Hz)
Max. torque at stirring shaft	900 Ncm	Max. torque at stirring shaft	3000 Ncm
Display	LED	Display	LED
Temp. sensor connection	no	Temp. sensor connection	no
Chuck range	1 – 10 mm	Chuck range	3 – 16 mm
Hollow shaft	yes	Hollow shaft	no
Dimensions (W x D x H)	123 x 252 x 364 mm	Dimensions (W x D x H)	145 x 358 x 465 mm
Weight	7.5 kg	Weight	16 kg
Permissible ambient temp.	5 – 40 °C	Permissible ambient temp.	5 – 40 °C
Permissible relative moisture	80%	Permissible relative moisture	80%
Protection class DIN EN 60529	IP 40	Protection class DIN EN 60529	IP 54

Ident. No. 0005040000

[RW 28 digital Package](#)

Ident. No. 0009023200

Ident. No. 0004050000

[RW 47 digital Package](#)

Ident. No. 0009023300

Package details
on page 158

Overhead Stirrers | Accessories

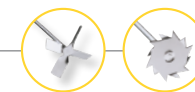

Propeller stirrer, 4-bladed

Standard stirring element for drawing the material to be mixed from the top to the bottom. It creates local shearing forces and axial flow in the vessel. This propeller stirrer is used at medium to high speeds.

Name	R 1342	R 1345	R 2302
Ident. No.	0000741000	0000741300	0000739000
Stirrer (∅)	50 mm	100 mm	150 mm
Shaft (∅)	8 mm	8 mm	13 mm
Shaft length	350 mm	540 mm	800 mm



Propeller stirrer, 3-bladed

Flow-efficient design for drawing the material to be mixed from the top and the bottom while creating minimum shearing forces. This propeller stirrer is used at medium to high speeds.

Name	R 1381	R 1382	R 1401	R 1405
Ident. No.	0001296000	0001295900	0001242900	0001289800
Stirrer (∅)	45 mm	55 mm	55 mm	45 mm
Shaft (∅)	8 mm	8 mm	—	—
Shaft length	350 mm	350 mm	—	—



Propeller stirrer, 3-bladed

Flow-efficient design for drawing the material to be mixed from the top and the bottom while creating minimum shearing forces. This propeller stirrer is used at medium to high speeds.

Name	R 1385	R 1388	R 1389 (PTFE-coated)
Ident. No.	0000477700	0000477800	0002343600
Stirrer (∅)	140 mm	140 mm	75 mm
Shaft (∅)	10 mm	10 mm	8 mm
Shaft length	550 mm	800 mm	350 mm



Turbine stirrer

This stirrer is used for drawing the material to be mixed from above while generating axial flow within the vessel. It carries a minimum level of danger of injury when contact is made with vessel. It also creates minimum shearing forces and is used at medium to high speeds.

Name	R 1311	R 1312	R 1313
Ident. No.	0002332900	0002333000	0002333100
Stirrer (∅)	30 mm	50 mm	70 mm
Shaft (∅)	8 mm	8 mm	10 mm
Shaft length	350 mm	350 mm	400 mm



Centrifugal stirrer

Two-bladed stirrer who's blades open with increasing speed. Perfect for stirring in round vessels with narrow necks and the effect is similar to that of a 4-bladed propeller stirrer. Medium to high speeds required.

Name	R 1352	R 1355
Ident. No.	0000756900	0001132700
Stirrer (∅)	60 / 15 mm	100 / 24 mm
Shaft (∅)	8 mm	8 mm
Shaft length	350 mm	550 mm



Dissolver stirrer

This stirrer provides radial flow for drawing the material to be mixed from the top and the bottom while creating high turbulence and high shearing forces for particle reduction. Medium to high speeds required.

Name	R 1300	R 1302	R 1303	R 1402
Ident. No.	0000513500	0002387900	0002746700	0001243300
Stirrer (∅)	80 mm	100 mm	42 mm	42 mm
Shaft (∅)	8 mm	10 mm	8 mm	—
Shaft length	350 mm	350 mm	350 mm	—



EUROSTAR 20 | 40 digital

(A)



EUROSTAR 100 digital | control

(B)



EUROSTAR 200 digital | control

(C)



EUROSTAR 200 control P4

(D)



EUROSTAR 20 high speed digital | control

(E)



RW 20 digital

(F)



RW 28 digital

(G)



RW 47 digital

(H)

Overhead Stirrers | Accessories



Paddle stirrer

This stirrer creates tangential flow, minimum turbulence, good heat exchange and gentle treatment of the product. Low to medium speeds required.

Name	R 1375	R 1376	R 2311
Ident. No.	0000757700	0000757800	0000739500
Stirrer (Ø)	70 mm	150 mm	150 mm
Shaft (Ø)	8 mm	10 mm	13 mm
Shaft length	550 mm	550 mm	800 mm



Anchor stirrer

This stirrer creates tangential flow, high shearing rate at the edges, minimum deposits on the vessel wall making them great for polymer reactions and even distribution of high mineral contents in liquids. Ideal for medium to highly viscous fluids. Low speeds required.

Name	R 1330	R 1331	R 1333
Ident. No.	0002022300	0002022400	0002747400
Stirrer (Ø)	45 mm	90 mm	150 mm
Shaft (Ø)	8 mm	8 mm	10 mm
Shaft length	350 mm	350 mm	550 mm



Moebius stirrer

Generates axial flow. For drawing the material to be mixed from above. For circulating and handling low to medium viscous liquids. Used at medium speeds.

Name	R 3000.1	R 3001.1
Ident. No.	0020001192	0020001195
Stirrer (Ø)	100 mm	100 mm
Shaft (Ø)	10 mm	10 mm
Shaft length	565 mm	575 mm



Spiral stirrer

Generates axial flow. Medium is conveyed from the bottom upwards. For homogeneous mixing and heat exchange of medium to high viscosity media. Used at low to medium speeds.

Name	R 3003	R 3003.1	R 3003.2
Ident. No.	0020001203	0020001204	0020001205
Stirrer (Ø)	50 mm	100 mm	150 mm
Shaft (Ø)	8 mm	10 mm	10 mm
Shaft length	350 mm	550 mm	800 mm



Blade stirrer

Generates a radial flow. For drawing the material to be mixed from the top and bottom. For aerating of low viscosity media and for homogenizing solids in liquids. Used at medium to high speeds.

Name	R 3004	R 3004.1	R 3004.2
Ident. No.	0020001206	0020001207	0020001208
Stirrer (Ø)	30 mm	50 mm	70 mm
Shaft (Ø)	8 mm	8 mm	10 mm
Shaft length	359 mm	565 mm	819 mm



EUROSTAR 20 | 40 digital

A



EUROSTAR 60 digital | control

B



EUROSTAR 100 digital | control

C



EUROSTAR 200 control P4

D



EUROSTAR 20 high speed digital | control

E



RW 20 digital

F



RW 28 digital

G



RW 47 digital

H



Overhead Stirrers | Accessories

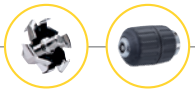

EUROSTAR 20 high speed digital | control accessories

	Ident. No.
① R 1401	0001242900
Propeller, Ø 55 mm	
② R 1405	0001289800
Propeller, Ø 45 mm	
③ R 1402	0001243300
Dissolver, Ø 42 mm	

Accessories for EUROSTAR control series

	Ident. No.
④ H 62.51*	0002735451
Temperature sensor, stainless steel, Ø 3 mm, 260 mm length	
⑤ H 66.51*	0002735551
Temperature sensor, stainless steel, glass-coated, Ø 6 mm, 260 mm length	
H 66.53*	0004499900
Temperature sensor, coated with SafeCoat, Ø 3 mm, 260 mm length	
H 67.60	0025000215
Temperature sensor, stainless steel, Ø 3 mm	
H 67.61	0020003865
Temperature sensor, stainless steel, Ø 3 mm, response time 0.9 = 4 s	
H 70*	0002735600
Extension cable, 1 m	
WH 11	0025001500
Wall mount for WiCo	
labworldsoft®	0004720000
Laboratory software	

* For using the temperature sensors, H 70 cable is required



RW 47 digital accessories

	Ident. No.
⑦ R 303	0030000257
Stirring shaft protection for RW 47 digital	
⑧ SI 400	0003294800
Safety switch	
⑨ SI 472	0003264000
Fixing device for R 472 stand	
⑩ SI 474	0003264400
Fixing device for R 474 and T 653 stand	

RW 20 digital & EUROSTAR series accessories

	Ident. No.
⑪ FK 1	0002336000
Flexible coupling, clamping range 6 – 10 mm	
⑫ R 60	0003889500
Keyless chuck for EUROSTAR 20 / 40 / 60 / 100 series	
⑬ R 301	0002603000
Stirring shaft protection, plexiglass	
⑭ R 301.1	0002604000
Support holder for R 301	

Shakers



IKA® offers a wide range of lab shakers for mixing and shaking applications. Products are equipped with digital display, timer function, and controlling options via the lab software labworldsoft®. Integrated end point positioning allows for automated sampling. An extensive array of attachments is available for the use of different vessels.



Sleek, compact, high-performance shaker

- > Controls with antimicrobial coating for reduction of bacteria
- > Electronic timer



 Assure highly accurate temperature control

 Orbital action

KS 3000 ic control **KS 4000 ic control**

 Built-in cooling coil for connection to an external cooling unit (available only for KS 3000 ic control)

 Wide range of attachments allows using almost all shapes and sizes of vessels

Shakers

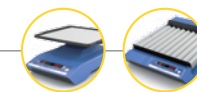

Roller 6 digital

Timer Display

Timer display for accurate and reproducible conditions



Touch keypad for easy operation



C/T button for choosing the counter or the timer function

Technical data

	Rocker 2D basic digital	Rocker 3D basic digital
Type of movement	rocking	tumbling
Shaking diameter	8° (angle) 2.5 – 15° (angle)	8° (angle) 0 – 15° (angle)
Permissible shaking weight (incl. attachment)	2 kg	2 kg
Motor rating input / output	16 / 9 W	16 / 9 W
Speed range	5 – 80 rpm	30 rpm (fixed) 5 – 80 rpm
Speed display	7 segment LED	none 7 segment LED
Timer	no ∞ / 1 s – 99.9 h	no ∞ / 1 s – 99.9 h
Timer display	none 7 segment LED	none 7 segment LED
Dimensions (W x D x H)	280 x 330 x 150 mm	280 x 330 x 165 mm 280 x 330 x 185 mm
Weight	2.2 kg 2.2 kg	2.2 kg

Ident. No. 0004002000*
Ident. No. 0004003000*

Ident. No. 0004000000*
Ident. No. 0004001000*

* RD 1 Universal mat included in the delivery of all Rockers

Technical data

	Roller 6 basic digital	Roller 10 basic digital
Type of movement	rocking and rolling	rocking and rolling
Shaking diameter	24.5 mm (high)	24.5 mm (high)
Permissible shaking weight (incl. attachment)	2 kg	2 kg
Motor rating input / output	16 / 9 W	16 / 9 W
Speed range	30 rpm (fixed) 5 – 80 rpm	30 rpm (fixed) 5 – 80 rpm
Speed display	none 7 segment LED	none 7 segment LED
Timer	no ∞ / 1 s – 99.9 h	no ∞ / 1 s – 99.9 h
Timer display	none 7 segment LED	none 7 segment LED
Dimensions (W x D x H)	240 x 545 x 115 mm	380 x 545 x 115 mm
Weight	4.5 kg	6 kg

Ident. No. 0004010000
Ident. No. 0004011000

Ident. No. 0004012000
Ident. No. 0004013000

Shakers

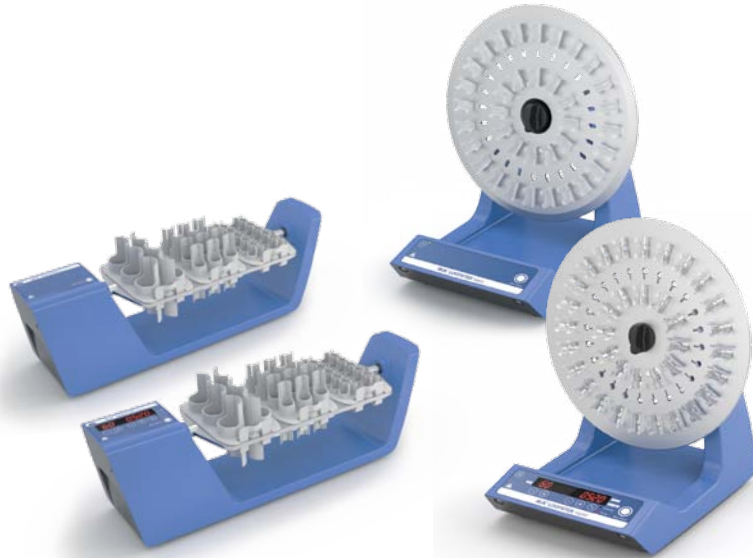
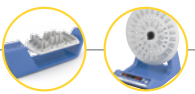

Loopster digital



Choice of tube holders to hold a number of different sized tubes



90 degree adjustable mixing angle

Technical data	Trayster basic digital	Loopster basic digital
Type of movement	rotating	rotating
Permissible shaking weight (incl. attachment)	2 kg	2 kg
Motor rating input / output	16 / 9 W	16 / 9 W
Speed range	20 rpm (fixed) 5 – 80 rpm	20 rpm (fixed) 5 – 80 rpm
Speed display	none 7 segment LED	none 7 segment LED
Timer	no ∞ / 1 s – 99.9 h	no ∞ / 1 s – 99.9 h
Timer display	none 7 segment LED	none 7 segment LED
Dimensions (W x D x H)	460 x 160 x 150 mm	300 x 300 x 360 mm
Weight	1.7 kg	3 kg
	Ident. No. 0004005000* Ident. No. 0004006000*	Ident. No. 0004015000* Ident. No. 0004016000*

* Loopster and Trayster accessories have to be ordered separately



Touch keypad for easy operation



Rotating action



Timer display for accurate and reproducible conditions



Shakers



MS 3 digital



Orbital action



Wide range of attachments



Continuous or touch operation



Technical data

	VORTEX 1	lab dancer	MS 3 basic digital
Type of movement	orbital	orbital	orbital
Shaking diameter	4.5 mm	4.5 mm	4.5 mm
Permissible shaking weight (incl. attachment)	0.1 kg	max. 50 ml (1 test tube)	0.5 kg
Motor rating input / output	1.2 / 0.8 W	1.2 / 0.8 W	10 / 8 W
Speed range	1000 – 2800 rpm	2800 rpm (fixed)	0 – 3000 rpm
Speed display	none	none	scale digital
Timer display	none	none	none digital
Operating mode	touch operation	touch operation	continuous / touch operation timer and continuous / touch operation
Dimensions (W x D x H)	95 x 110 x 70 mm	100 x 70 mm (Ø x H)	148 x 205 x 63 mm
Weight	0.55 kg	0.55 kg	2.9 kg
Permissible ambient temp.	5 – 40 °C	5 – 40 °C	5 – 40 °C
Permissible relative moisture	80%	80%	80%
	Ident. No. 0004047700	Ident. No. 0003365000	Ident. No. 0003617000 Ident. No. 0003319000

VORTEX3



Orbital action



Wide speed range enables intensive mixing, even for small vessels



Different applications easily handled with interchangeable attachments and inserts



Technical data

	VORTEX 3	VXR basic Vibrax®	MTS 2/4 digital Microtiter shaker
Type of movement	orbital	orbital	orbital
Shaking diameter	4 mm	4 mm	3 mm
Permissible shaking weight (incl. attachment)	0.4 kg	2 kg	2 or 4 microtiter plates (MTP)
Motor rating input / output	58 / 10 W	35 / 13.2 W	35 / 13.2 W
Speed range	500 – 2500 rpm	0 – 2200 rpm	0 – 1100 rpm
Speed display	scale (0 – 6)	scale	scale
Timer	none	none	∞ / 1 – 99 min
Operating mode	continuous / touch operation	continuous operation	timer and continuous operation
Dimensions (W x D x H)	127 x 149 x 136 mm	157 x 247 x 130 mm	185 x 320 x 105 mm
Weight	4.5 kg	6.1 kg	2.7 kg
Permissible ambient temp.	5 – 40 °C	5 – 40 °C	5 – 40 °C
Permissible relative moisture	80%	80%	80%
	Ident. No. 0003340000	Ident. No. 0002819000	Ident. No. 0003208000

Shakers

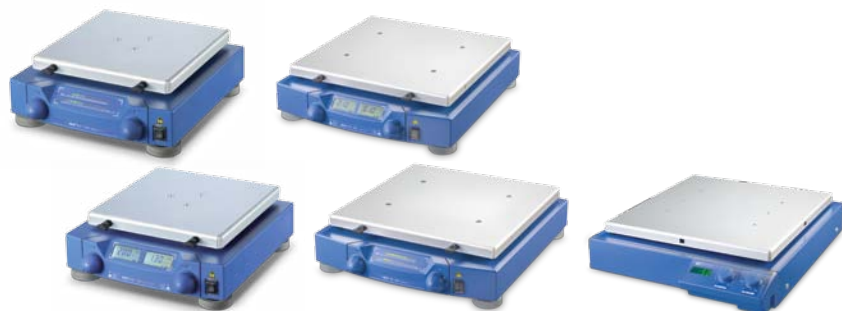

	KS 130 basic control (NOL*)	HS 260 basic control (NOL*)	HS 501 digital
Technical data			
Type of movement	orbital	reciprocating	reciprocating
Shaking diameter	4 mm	20 mm	30 mm
Permissible shaking weight (incl. attachment)	2 kg	7.5 kg	15 kg
Motor rating input / output	45 / 10 W	45 / 10 W	70 / 19 W
Permissible ON time	100 %	100 %	100 %
Speed range	0 – 800 rpm	0 – 300 rpm 10 – 300 rpm	0 – 300 rpm
Speed display	LED line	LED line digital	digital
Timer	∞ / 5 – 50 min ∞ / 0 – 9 h 59 min	∞ / 5 – 50 min ∞ / 0 – 9 h 59 min	∞ / 1 – 56 min
Operating mode	timer and continuous operation	timer and continuous operation	timer and continuous operation
Dimensions (W x D x H)	270 x 316 x 98 mm	360 x 420 x 100 mm	505 x 585 x 120 mm
Weight	8.8 kg	8.5 kg 8.8 kg	26 kg
Permissible ambient temp.	5 – 50 °C	5 – 50 °C	5 – 50 °C
Permissible relative moisture	80%	80%	80%
	KS 130 basic Ident. No. 0002980000 KS 130 control Ident. No. 0002980100 KS 130 control NOL* Ident. No. 0004278200	HS 260 basic Ident. No. 0003066600 HS 260 control Ident. No. 0003066700 HS 260 control NOL* Ident. No. 0004278600	Ident. No. 0002527000

* No End-point positioning



Wide range of attachment combinations



Orbital action



Digital display allows reading of speed, timer function and operating modes



All functions can be controlled and documented with labworldsoft®



KS 260 control



	KS 260 basic control (NOL*)	KS 501 digital
Technical data		
Type of movement	orbital	orbital
Shaking diameter	10 mm	30 mm
Permissible shaking weight (incl. attachment)	7.5 kg	15 kg
Motor rating input / output	45 / 10 W	70 / 19 W
Permissible ON time	100%	100%
Speed range	20 – 500 rpm 10 – 500 rpm	0 – 300 rpm
Speed display	LED line digital	digital
Timer	∞ / 5 – 50 min ∞ / 0 – 9 h 59 min	∞ / 1 – 56 min
Timer display	LED line digital	digital
Operating mode	timer and continuous operation	timer and continuous operation
Dimensions (W x D x H)	360 x 420 x 98 mm	505 x 585 x 120 mm
Weight	8.5 kg 8.8 kg	26 kg
Permissible ambient temp.	5 – 50 °C	5 – 50 °C
Permissible relative moisture	80%	80%
	KS 260 basic Ident. No. 0002980200 KS 260 control Ident. No. 0002980300 KS 260 control NOL* Ident. No. 0004278400	Ident. No. 0002526400

* No End-point positioning

Incubator Shakers



KS 3000
ic control

KS 4000
ic control



Assure highly accurate temperature control



Orbital action

Technical data

	KS 3000 i control ic control	KS 4000 i control ic control
Type of movement	orbital	orbital
Shaking diameter	20 mm	20 mm
Permissible shaking weight (incl. attachment)	7.5 kg	20 kg
Motor rating input / output	45 / 10 W	82 / 24 W
Permissible ON time	100%	100%
Speed range	10 – 500 rpm	10 – 500 rpm
Speed display	LED	LED
Timer	1 s – 999 h	1 s – 999 h
Timer display	LED	LED
Operating mode	timer and continuous operation	timer and continuous operation
Dimensions (W x D x H)	465 x 430 x 695 mm	580 x 525 x 750 mm
Weight	35 kg 37 kg	50 kg 55 kg
Permissible ambient temp.	15 – 32 °C	15 – 32 °C
Permissible relative moisture	80%	80%
	Ident. No. 0003940000 Ident. No. 0003940100	Ident. No. 0003510000 Ident. No. 0003510100



Built-in cooling coil for connection to an external cooling unit (available only for KS 3000 ic / KS 4000 ic control)



Wide range of attachments allows using almost all shapes and sizes of vessels



USB interface to control and document all parameters using labworldsoft® software and for updating your firmware

Shakers | Accessories

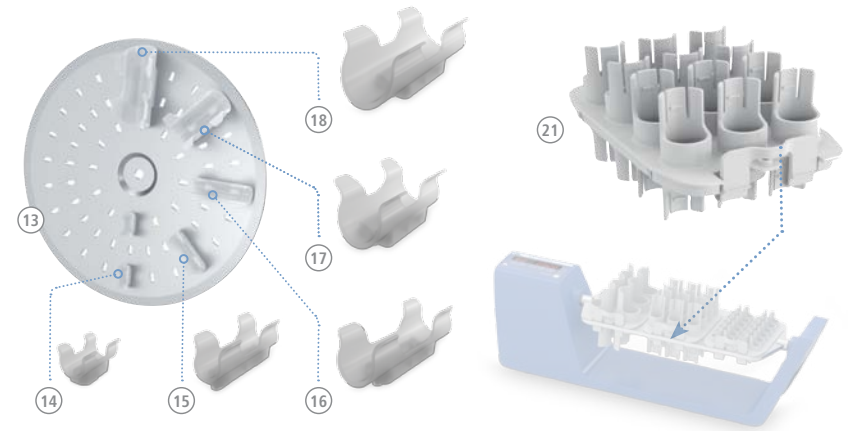
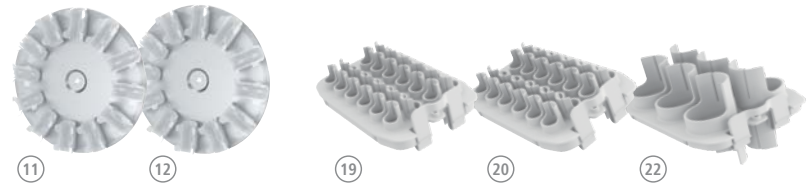
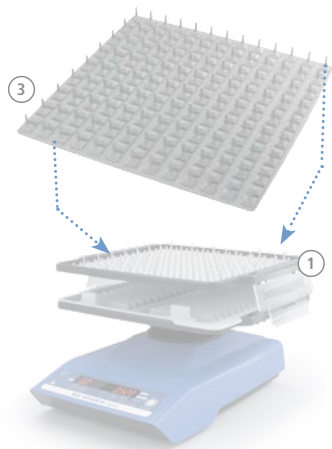
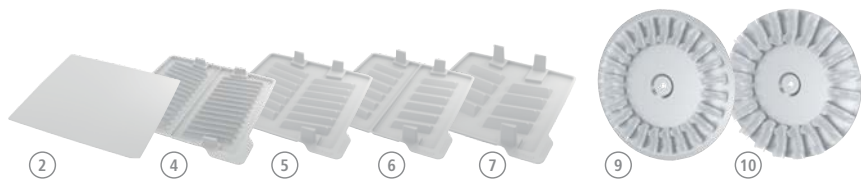
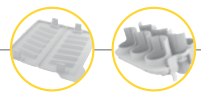

Rocker accessories

	Ident. No.
1 A 2 Second level attachment	0004581700
2 RD 1* Universal mat	0004532000
3 RD 2 Burled mat	0004532100
4 TB 1 Tray, 28 x 5 ml, Ø 12 mm	0004532200
5 TB 2 Tray, 16 x 15 ml, Ø 16 mm	0004532300
6 TB 3 Tray, 14 x 30 ml, Ø 25 mm	0004532400
7 TB 4 Tray, 10 x 50 ml, Ø 28 mm	0004532500

Loopster accessories

	Ident. No.
8 DS 1 Tube attachment, 48 x 1.5 ml, Ø 10 mm	0004524000
9 DS 2 Tube attachment, 24 x 5 ml, Ø 12 mm	0004524100
10 DS 3 Tube attachment, 20 x 15 ml, Ø 16 mm	0004524200
11 DS 4 Tube attachment, 12 x 30 ml, Ø 25 mm	0004524300
12 DS 5 Tube attachment, 12 x 50 ml, Ø 28 mm	0004524400
13 DS 6 Universal disc	0004524500

Trayster accessories

	Ident. No.
14 DS 6.1 Spare clips, Ø 10 mm, 12 pcs.	0004524600
15 DS 6.2 Spare clips, Ø 12 mm, 12 pcs.	0004524700
16 DS 6.3 Spare clips, Ø 16 mm, 12 pcs.	0004524800
17 DS 6.4 Spare clips, Ø 25 mm, 12 pcs.	0004524900
18 DS 6.5 Spare clips, Ø 28 mm, 12 pcs.	0004525000
19 TR 1 Tube insert, 24 x 1.5 ml, Ø 10 mm	0004525100
20 TR 2 Tube insert, 24 x 5 ml, Ø 12 mm	0004525200
21 TR 3 Tube insert, 12 x 15 ml, Ø 16 mm	0004525300
22 TR 4 Tube insert, 6 x 50 ml, Ø 28 mm	0004525400

* Included in the delivery

Shakers | Accessories

MS 3 basic / digital accessories

	Ident. No.
MS 3.1 Standard attachment	0003426300
MS 3.3 Universal attachment	0003426600
MS 1.21 One-hand insert	L001540
MS 1.31 Test tube insert, 14 x Ø 10 mm	L001840
MS 1.32 Test tube insert, 6 x Ø 12 mm	L001850
MS 1.33 Test tube insert, 4 x Ø 16 mm	L001860
MS 1.34 Test tube insert, without holes	L001830
MS 3.4 Microtiter plate attachment	0003426400
MS 3.5 PCR plate attachment, 96-well	0003428000



VORTEX 3 accessories

	Ident. No.
23 VG 3.1 Standard attachment	0003341200
24 VG 3.2 One-hand attachment, 88 mm	0003342300
VG 3.21 Rubber pad, for VG 3.2 One-hand attachment	0004206500
25 VG 3.3 Universal attachment, 150 mm	0003342400
26 VG 3.31* Test tube attachment for 54 Eppendorf tubes	0003344300
27 VG 3.32* Test tube attachment, 18 x Ø 10 mm	0003343900
28 VG 3.33* Test tube attachment, 12 x Ø 12 mm	0003344000
29 VG 3.34* Test tube attachment, 8 x Ø 16 mm	0003344100
30 VG 3.35* Test tube attachment, 8 x Ø 20 mm	0003344200
31 VG 3.36* Erlenmeyer flask attachment, 100 – 250 ml	0003342100
32 VG 3.37* Microtiter plate attachment	0003344400

* Used with VG 3.3 Universal Attachment, ordered separately

32



31



30



29



28



27

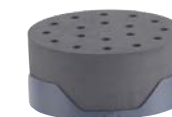

26



25



24



Shakers | Accessories

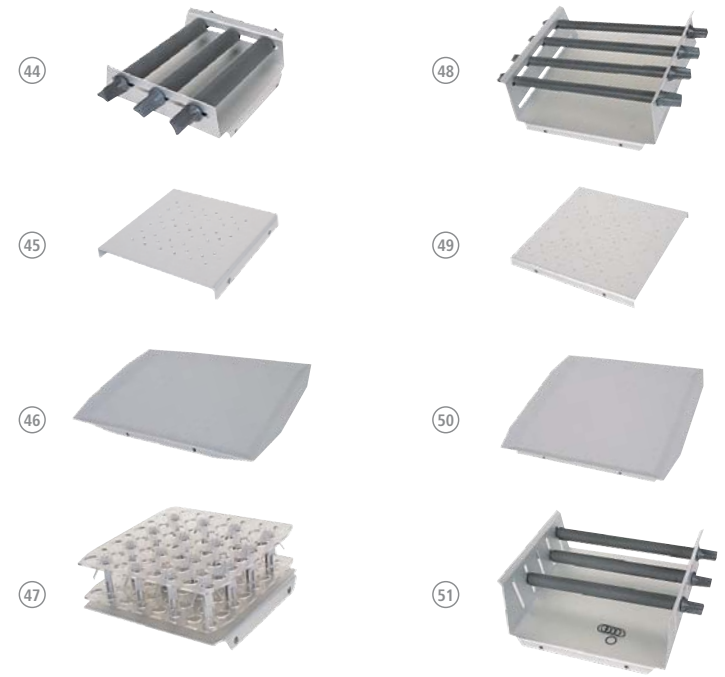
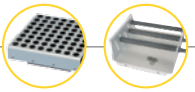

VXR basic accessories

	Ident. No.
33 VX 1	0000607200
One-hand attachment, 1 – 250 ml	
34 VX 2	0000568900
Test tube attachment, 36 x Ø 16 mm	
35 VX 2E	0001618100
Eppendorf attachment, 64 x 1.5 ml	
36 VX 7	0000953300
Dish attachment, 410 x 210 mm	
37 VX 8	0000910400
Universal attachment, 265 x 136 mm	

38 VX 11	0003627700
Basic holder	
39 VX 11.1	0003659000
Test tube insert, 70 x Ø 10 mm	
40 VX 11.2	0003659100
Test tube insert, 41 x Ø 12 mm	
41 VX 11.3	0003659200
Test tube insert, 32 x Ø 16 mm	
42 VX 11.4	0003659300
Test tube insert, 18 x Ø 20 mm	
43 VX 8.1	0003375400
Clamping roll	

KS 130 basic / control accessories

	Ident. No.
44 AS 130.1	0008017300
Universal attachment, set-up plate 220 x 220 mm	
45 AS 130.2	0003115000
Fixing clip attachment, set-up plate 230 x 230 mm	
46 AS 130.3	0003120000
Dish attachment, set-up plate 220 x 340 mm	
47 AS 130.4	0003120300
Test tube attachment, 64 x Ø 10 – 16 mm	

KS / HS 260 basic / control and KS 3000 accessories

	Ident. No.
48 AS 260.1	0008017400
Universal attachment, set-up plate 320 x 320 mm	
49 AS 260.2	0003115500
Fixing clip attachment, set-up plate 330 x 330 mm	
50 AS 260.3	0003120600
Dish attachment, set-up plate 320 x 320 mm	
51 AS 260.5	0003120900
Separating funnel attachment	

KS / HS 501 digital accessories

	Ident. No.
AS 501.1	0008000200

Universal attachment, set-up plate 420 x 420 mm

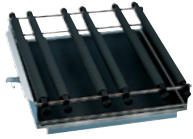

AS 501.4	0002341100
----------	------------

Fixing clip attachment, set-up plate 450 x 450 mm

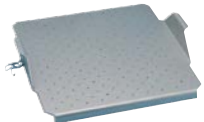

AS 501.5	0002339600
----------	------------

Dish attachment, set-up plate 420 x 420 mm



AS 501.2	0008000300
----------	------------

Separating funnel attachment, 480 x 505 x 190 mm

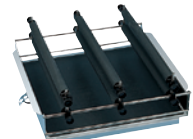

AS 501.3	0008000400
----------	------------

Separating funnel attachment, 480 x 505 x 190 mm

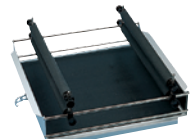

AS 501.6	0008000500
----------	------------

Separating funnel attachment, 480 x 505 x 225 mm



Other accessories

	Ident. No.
AS 1.30	0003148000

Basic holder for AS 130.1

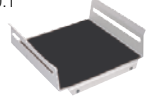

AS 1.60	0003149000
---------	------------

Basic holder for AS 260.1

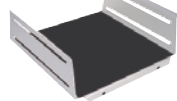

AS 1.10	0002339700
---------	------------

Basic holder for AS 501.1

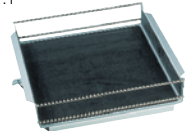

AS 1.31 AS 1.61 AS 1.11	0003030500
	0003030501
	0002339800

Clamping roll for AS 130.1, AS 260.1, AS 501.1



AS 1.6	0001268400
--------	------------

Clamping device for AS 501.1



AS 1.7	0001269200
--------	------------

Clamping device for AS 501.1



AS 1.8	0001268900
--------	------------

Supporting clamping device for AS 501.1



AS 1.12	0002594500
---------	------------

Supporting bar for AS 1.10



AS 1.13	0002597000
---------	------------

Ground section holder for AS 1.10



Shakers | Accessories

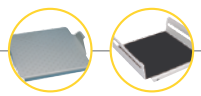



IKA[®]+

STICKMAX
Universal adhesive mat,
200 x 200 mm

Ident. No. 0003920000

AS 2.1	0001234300
--------	------------

Fixing clips, 25 ml



AS 2.2	0001234400
--------	------------

Fixing clips, 50 ml



AS 2.3	0001234500
--------	------------

Fixing clips, 100 ml



AS 2.4	0001234600
--------	------------

Fixing clips, 200 / 250 ml



AS 2.5	0001234700
--------	------------

Fixing clips, 500 ml



AS 2.6	0003819300
--------	------------

Fixing clips, 1000 ml

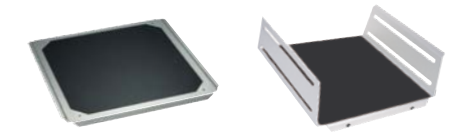
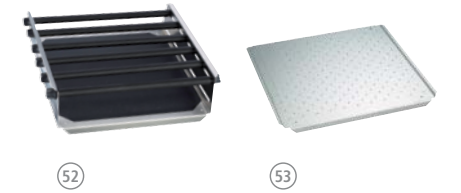

KS 4000 accessories i / ic control accessories

AS 4000.1	0008022200
-----------	------------

Universal attachment, set-up plate 380 x 410 mm

AS 4000.2	0003710100
-----------	------------

Fixing clip attachment, set-up plate 430 x 430 mm

AS 4000.3	0003710000
-----------	------------

Dish attachment, set-up plate 430 x 430 mm

AS 1.400	0003710200
----------	------------

Basic holder for AS 4000.1

AS 1.401	0003712000
----------	------------

Clamping roll for AS 4000.1

AS 1.402	0003712300
----------	------------

Fastening screw for AS 4000.1

Dispersers



IKA®'s ULTRA-TURRAX® – used for homogenizing, emulsifying or suspending. The digital display allows you to keep track of the speed and the development of the products focused on a soft start of the motor. There is a broad spectrum of dispersing tools to choose from. Common disperser applications include: homogenization of effluent samples, dispersing tasks under vacuum pressure, and PCR analysis.



High-performance dispersing instrument!

- > Work at high circumferential speeds
- > Enables the best possible results for any application



- Digital Display** Digital display for precise monitoring of set and actual speeds
- Wide selection of dispersing tools** Wide selection of dispersing tools to suit your application
- Rotating knob** Rotating knob for adjusting the speed
- Motor protection** Motor protection against overload
- Quick-connect coupling** Quick-connect coupling to exchange dispersing tools easily



ULTRA-TURRAX® Tube Drive

Patented



UTTD ULTRA-TURRAX®
Tube Drive

ULTRA-TURRAX®
Tube Drive control

Technical data

Motor rating input / output	20 / 17 W	20 / 17 W
Speed range / Turbo speed	300 – 6000 rpm / –	400 – 6000 rpm / 8000 rpm
Display / Speed display	LED (timer) / scale	OLED / digital
Timer	1 s – 29 min	10 s – 30 min (infinitely adjustable)
Reverse rotation interval	–	10 – 60 s
Dimensions (W x D x H)	100 x 40 x 160 mm	122 x 178 x 48 mm
Weight	0.75 kg	1.0 kg
Protection class DIN EN 60529	IP 20	IP 20
Interface	yes	yes
Voltage	100 – 240 V	100 – 240 V
Frequency	50/60 Hz	50/60 Hz

Ident. No. 0003646000

Ident. No. 0004135300



UTTD
Workstation

ULTRA-TURRAX® Tube Drive
control Workstation

Included with delivery

ULTRA-TURRAX® Tube Drive	1	1
SF-20 Tube with stirring device	2	1
DT-20 Tube with rotor-stator element	2	1
BMT-20 G / S Tube for grinding with glass (G) or stainless steel balls (S)	2	2
Removal hook for removal of rotor-stator	1	1
Power supply	1	1

Ident. No. 0003645000

Ident. No. 0003827500

No cleaning efforts
No cross-contamination
Reproducible test results



Tube
Drive
control



reddot design award
winner 2012



Turbo function for short
time intensive mixing,
homogenizing or grinding



Built-in program library for
tests to be repeated under
identical conditions



Reverse rotation switch
to optimize mixing and
crushing performance



Multilingual OLED display
for simple and precise
menu navigation



USB interface to control and
document all the parameters
using labworldsoft® software
and for updating your firmware



Watch the video now:
www.ika.com/video



ULTRA-TURRAX® Tube Drive | Accessories



ST Tube with stirring devices

	Ident. No.
ST-20 (pack of 25)	0003703000
ST-20-M-gamma (pack of 20)	0003700500
ST-50 (pack of 10)	0003699500
ST-50-M (pack of 10)	0003629500
ST-50-M-gamma (pack of 10)	0003701500

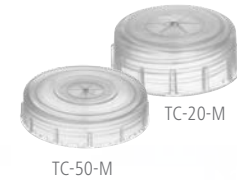

Cover for BMT tube

	Ident. No.
TC-50; for 50 ml tubes (10 pcs.)	0003749800
TC-20-M; with pierceable membrane for 20 ml tubes (25 pcs.)	0003749900
TC-50-M; with pierceable membrane for 50 ml tubes (10 pcs.)	0003750000



DT Tube with rotor-stator element

	Ident. No.
DT-20 (pack of 25)*	0003703100
DT-20-M-gamma (pack of 20)*	0003700600
DT-20 eco (pack of 25)**	0020003207
DT-50 (pack of 10)*	0003699600
DT-50-M (pack of 10)*	0003629600
DT-50-M-gamma (pack of 10)*	0003701600
DT-50 eco (pack of 10)**	0020003213

* Rotor-stator element made with PEEK

** Rotor-stator element made with PSU



BMT-S/G Tube for grinding with stainless steel (S) or glass (G) balls

	Ident. No.
BMT-20-S (pack of 25)	0003703200
BMT-20-G (pack of 25)	0003703300
BMT-20-S-M-gamma (pack of 20)	0003700700
BMT-50-S (pack of 10)	0003699700
BMT-50-G (pack of 10)	0003699800
BMT-50-S-M (pack of 10)	0003629700
BMT-50-G-M (pack of 10)	0003629800
BMT-50-S-M-gamma (pack of 10)	0003701700

Balls for BMT tube

	Ident. No.
Glass balls Ø 6 mm (250 g)	0003599200
Stainless steel balls Ø 5 mm (250 g)	0003599300



T-series ULTRA-TURRAX® Dispensers



PCR kit



reddot design award
winner 2012



reddot design award
winner 2012



Dispensing tools are not included in delivery

Technical data

	T 10 basic T 10 standard PCR kit	T 18 digital	T 25 digital
Motor rating input / output	125 / 75 W	500 / 300 W	800 / 500 W
Volume range (H ₂ O)	0.5 – 100 ml	1 – 1500 ml	1 – 2000 ml
Viscosity max.	5000 mPas	5000 mPas	5000 mPas
Speed range	8000 – 30,000 rpm 8000 – 26,000 rpm	3000 – 25,000 rpm	3000 – 25,000 rpm
Speed display	scale	LED	LED
Speed control	stepless	stepless	stepless
Noise without element	65 dB(A)	75 dB(A)	75 dB(A)
Extension arm diameter	8 mm	13 mm	13 mm
Extension arm length	130 mm	160 mm	160 mm
Process type	batch	batch	batch
Dimensions (W x D x H)	56 x 66 x 178 mm	87 x 106 x 271 mm	87 x 106 x 271 mm
Weight	0.5 kg	2.5 kg	2.5 kg
Perm. ambient temperature	5 – 40 °C	5 – 40 °C	5 – 40 °C
Permissible relative moisture	80 %	80 %	80 %
Protect. class DIN EN 60529	IP 30	IP 20	IP 20
Interface	no	no	no
Voltage	230 V	200 – 240 V	200 – 240 V
Frequency	50/60 Hz	50/60 Hz	50/60 Hz

T 10 basic
Ident. No. 0003737000
T 10 PCR kit
Ident. No. 0004095500

T 18 digital
Ident. No. 0003720000
T 18 digital Package
Ident. No. 0009022800

Ident. No. 0003725000



Watch the video:
www.ika.com/video



Dispensing tools are not included in delivery

Technical data

	T 50 digital	T 65 basic	T 65 digital
Motor rating input / output	1100 / 700 W	1800 / 1500 W	2600 / 2200 W
Volume range (H ₂ O)	0.25 – 30 l	2 – 50 l	2 – 50 l
Viscosity max.	5000 mPas	5000 mPas	5000 mPas
Speed range	600 – 10,000 rpm	7200 rpm (fixed)	1000 – 9500 rpm
Speed display	LED	–	LED
Speed control	stepless	fixed	stepless
Noise without element	72 dB(A)	75 dB(A)	75 dB(A)
Extension arm diameter	16 mm	flange	flange
Extension arm length	220 mm	flange	flange
Process type	batch	batch	batch
Dimensions (W x D x H)	115 x 139 x 355 mm	185 x 400 x 450 mm	300 x 400 x 390 mm
Weight	5.76 kg	26 kg	29 kg
Perm. ambient temperature	5 – 40 °C	5 – 40 °C	5 – 40 °C
Permissible relative moisture	80 %	80 %	80 %
Protect. class DIN EN 60529	IP 20	IP 54	IP 54
Interface	no	no	no
Voltage	200 – 240 V	3 x 400 / 3 x 230 V	3 x 400 / 3 x 230 V
Frequency	50/60 Hz	50 Hz	50/60 Hz

Ident. No. 0003787000

Ident. No. 0004023500
T 65 basic Package
Ident. No. 0009023400

Ident. No. 0004234500
T 65 digital Package
Ident. No. 0009023500

Dispersing tools

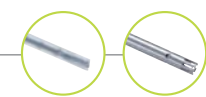

	T 10 basic
Dispersing element	S 10 N – 5 G
Ident. No.	0003304000
Working range	0.5 – 10 ml
Stator diameter	5 mm
Rotor diameter	3.8 mm
Gap between rotor and stator	0.1 mm
Min. / max. immersion depth	20 / 75 mm
Shaft length	92 mm
Materials in contact with medium	PTFE, AISI 316L
pH range	2 – 13
Suitable for solvents	yes
Max. temperature	180 °C
Sterilization methods	all methods

③

	T 18 digital
Dispersing element	S 18 N – 10 G
Ident. No.	L004639
Working range	1 – 100 ml
Stator diameter	10 mm
Rotor diameter	7.5 mm
Gap between rotor and stator	0.35 mm
Min. / max. immersion depth	25 / 70 mm
Shaft length	108 mm
Materials in contact with medium	PTFE, AISI 316L
pH range	2 – 13
Suitable for solvents	yes
Max. temperature	180 °C
Sterilization methods	all methods

⑧

	T 10 basic	
Dispersing element	S 10 N – 8 G – ST	S 10 N – 10 G – ST
Ident. No.	0004446500	0004446700
Working range	1 – 50 ml	1 – 100 ml
Stator diameter	8 mm	10 mm
Rotor diameter	6.1 mm	7.6 mm
Gap between rotor and stator	0.25 mm	0.2 mm
Min. / max. immersion depth	20 / 95 mm	20 / 100 mm
Shaft length	115 mm	115 mm
Materials in contact with medium	PTFE, AISI 316L	PTFE, AISI 316L

①

②

T 10 basic			
S 10 N – 8 G	S 10 N – 10 G	S 10 D – 7 G – KS – 65	S 10 D – 7 G – KS – 110
0003305500	0003370100	0020002076 (24 pcs.)	0020002075 (24 pcs.)
1 – 50 ml	1 – 100 ml	1 – 20 ml	1 – 40 ml
8 mm	10 mm	7 mm	7 mm
6.1 mm	7.6 mm	4.8 mm	4.8 mm
0.25 mm	0.2 mm	0.3 mm	0.3 mm
20 / 95 mm	20 / 100 mm	20 / 50 mm	20 / 90 mm
115 mm	115 mm	65 mm	110 mm
PTFE, AISI 316L	PTFE, AISI 316L	Polycarbonate (PC) Polysulfon (PSU)	Polycarbonate (PC) Polysulfon (PSU)
2 – 13	2 – 13	–	–
yes	yes	–	–
180 °C	180 °C	100 °C	100 °C
all methods	all methods	yes, autoclavable	yes, autoclavable

④

⑤

⑥

⑦

S 18 series		
S 18 N – 19 G	S 18 D – 10 G – KS	S 18 D – 14 G – KS
L004640	0003452400 (12 pcs.)	0003452300 (12 pcs.)
10 – 1500 ml	10 – 100 ml	10 – 500 ml
19 mm	10 mm	14 mm
12.7 mm	6.75 mm	9.5 mm
0.4 mm	0.25 mm	0.35 mm
35 / 170 mm	15 / 85 mm	15 / 85 mm
204 mm	150 mm	150 mm
PTFE, AISI 316L	Polycarbonate (PC) Polyetheretherketon (PEEK)	Polycarbonate (PC) Polyetheretherketon (PEEK)
2 – 13	–	–
yes	–	–
180 °C	100 °C	100 °C
all methods	yes, autoclavable	yes, autoclavable

⑨

⑩

⑪

Disposable tube
S 18 / 25-ET50
For attaching onto
plastic tools from S 18 D
and S 25 D series.

Ident. No. 0003452500
Material PP





12



13



14



15



16



17

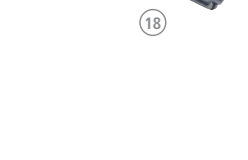

18

Dispersing element

Ident. No.	
Working range	
Stator diameter	
Rotor diameter	
Gap between rotor and stator	
Min. / max. immersion depth	
Shaft length	
Materials in contact with medium	

T 25 digital

Dispersing element	S 25 N – 8 G
Ident. No.	0001024200
Working range	1 – 50 ml
Stator diameter	8 mm
Rotor diameter	6.1 mm
Gap between rotor and stator	0.25 mm
Min. / max. immersion depth	27 / 85 mm
Shaft length	108 mm
Materials in contact with medium	PTFE, AISI 316L
pH range	2 – 13
Suitable for solvents	yes
Max. temperature	180 °C
Sterilization methods	all methods
Min. vacuum	–
Max. pressure	–

16

Dispersing tools



Saw Tooth (ST) dispersing tools

- > ST tools are recommended to use with tissue and other fibrous materials
- > Saw tooth designs create a cutting and tearing action for shredding fibrous materials
- > Made of high quality stainless steel



T 25 digital

S 25 N – 8 G – ST	S 25 N – 10 G – ST	S 25 N – 18 G – ST	S 25 N – 25 G – ST
0004446900	0004447100	0004447300	0004447500
1 – 50 ml	1 – 100 ml	10 – 1500 ml	50 – 2000 ml
8 mm	10 mm	18 mm	25 mm
6.1 mm	7.5 mm	13.4 mm	20 mm
0.25 mm	0.35 mm	0.3 mm	0.5 mm
27 / 85 mm	22 / 85 mm	40 / 165 mm	40 / 165 mm
108 mm	105 mm	194 mm	194 mm
PTFE, AISI 316L	PTFE, AISI 316L	PTFE, AISI 316L	PTFE, AISI 316L

12

13

14

15

S 25 N – 10 G	S 25 N – 18 G	S 25 KV – 18 G	S 25 NK – 19 G
0000594000	0000593400	0002348000	0002494700
1 – 100 ml	10 – 1500 ml	10 – 1500 ml	25 – 1500 ml
10 mm	18 mm	18 mm	19 mm
7.5 mm	12.7 mm	12.7 mm	12.7 mm
0.35 mm	0.3 mm	0.3 mm	0.3 mm
22 / 85 mm	40 / 165 mm	40 / 225 mm	40 / 165 mm
105 mm	194 mm	270 mm	194 mm
PTFE, AISI 316L	PTFE, AISI 316L	FFPM / SIC, AISI 316L	PTFE, AISI 316L
2 – 13	2 – 13	2 – 13	2 – 13
yes	yes	yes	yes
180 °C	180 °C	220 °C	120 °C
all methods	all methods	wet chemical	wet chemical
–	–	1 mbar	–
–	–	6 bar	–

17

18

Dispersing tools

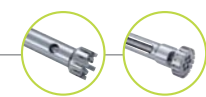

	T 25 digital	
Dispersing element	S 25 N – 25 G	S 25 KV – 25 G
Ident. No.	0001713300	0002466900
Working range	50 – 2000 ml	50 – 2000 ml
Stator diameter	25 mm	25 mm
Rotor diameter	17 mm	17 mm
Gap between rotor and stator	0.5 mm	0.5 mm
Min. / max. immersion depth	40 / 165 mm	40 / 225 mm
Shaft length	194 mm	270 mm
Materials in contact with medium	PTFE, AISI 316L	FFPM / SIC, AISI 316L
pH range	2 – 13	2 – 13
Suitable for solvents	yes	yes
Max. temperature	180 °C	220 °C
Sterilization methods	all methods	wet chemical
Min. vacuum	–	1 mbar
Max. pressure	–	6 bar

19



	T 25 digital
Dispersing element	S 25 – KR – 18 G
Ident. No.	0020002971
Working range	10 – 1500 ml
Stator diameter	18 mm
Rotor diameter	12.7 mm
Gap between rotor and stator	0.3 mm
Min. / max. immersion depth	40 – 185 mm
Shaft length	194 mm
Materials in contact with medium	FKM, PTFE, AISI 316L
pH range	2 – 13
Suitable for solvents	no
Max. temperature	110 °C
Sterilization methods	wet chemical
Min vacuum	50 mbar

Silentstream

The flow breaker is used to prevent vortexing and to minimize air induction into the medium.

Ident. No. 0003754000

Fits the following dispersing elements:

S 25 N – 18 G	S 25 KV – 18 G
S 25 N – 25 G	S 25 KV – 25 G
S 25 N – 25 F	S 25 KV – 25 F
S 25 NK – 19 G	S 18 N – 19 G

S 25 N – 25 F	S 25 KV – 25 F	S 25 D – 10 G – KS	S 25 D – 14 G – KS
0001713800	0002404000	0003452200 (12 pcs.)	0003452100 (12 pcs.)
100 – 2000 ml	100 – 2000 ml	10 – 100 ml	10 – 500 ml
25 mm	25 mm	10 mm	14 mm
18 mm	18 mm	6.75 mm	9.5 mm
0.5 mm	0.5 mm	0.25 mm	0.35 mm
40 / 165 mm	40 / 225 mm	15 / 85 mm	15 / 85 mm
194 mm	270 mm	150 mm	150 mm
PTFE, AISI 316L	FFPM / SIC, AISI 316L	Polycarbonate (PC) Polyetheretherketon (PEEK)	Polycarbonate (PC) Polyetheretherketon (PEEK)
2 – 13	2 – 13	–	–
yes	yes	–	–
180 °C	180 °C	100 °C	100 °C
all methods	all methods	yes, autoclavable	yes, autoclavable
–	–	–	–
–	–	–	–

20

21

22

S 25 – KR – 25 G	S 25 – KR – 18 G – ST	S 25 – KR – 25 G – ST	S 25 – KR – 25 F
0020002972	0020002973	0020002974	0020002975
50 – 2000 ml	10 – 1500 ml	50 – 2000 ml	100 – 2000 ml
25 mm	18 mm	25 mm	25 mm
17 mm	13.4 mm	20 mm	18 mm
0.5 mm	0.25 mm	0.5 mm	0.5 mm
40 – 185 mm	40 – 185 mm	40 – 185 mm	40 – 185 mm
194 mm	194 mm	194 mm	194 mm
FKM, PTFE, AISI 316L	FKM, PTFE, AISI 316L	FKM, PTFE, AISI 316L	FKM, PTFE, AISI 316L
2 – 13	2 – 13	2 – 13	2 – 13
no	no	no	no
110 °C	110 °C	110 °C	110 °C
wet chemical	wet chemical	wet chemical	wet chemical
50 mbar	50 mbar	50 mbar	50 mbar

TS 25-3

Cleaning tool for cleaning three dispersing elements. The cleaning tool consists of an aluminum stand, three cleaning tubes (PP) and three covers with openings (PP).

Ident. No. 0020003013

Material tubes	PP
Material lid	PP
Material stand	aluminum anodized

Fits the following dispersing elements:

S 25 N – 18 G / 18 G – ST
S 25 N – 25 G / F / 25 G – ST
S 25 KR – 18 G / 18 G – ST
S 25 KR – 25 G / 25 F / 25 G – ST
S 25 KV – 18 G / 25 G / 25 F

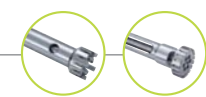

Dispersing tools



Dispersing element

Ident. No.
Working range
Stator diameter
Rotor diameter
Gap between rotor and stator
Min. / max. immersion depth
Shaft length
Min. vacuum
Max. pressure
Materials in contact with medium
pH range
Suitable for solvents
Max. temperature
Sterilization methods

T 50 digital			
S 50 KG – HH – G 45 G	S 50 KG – HH – G 45 G – ST	S 50 KG – HH – G 45 M	S 50 KG – HH – G 45 F
S 50 KG – HH – G 45 G FDA	S 50 KG – HH – G 45 G – ST FDA	S 50 KG – HH – G 45 M FDA	S 50 KG – HH – G 45 F FDA
0008003200	0010000648	0008003500	0008004100
0010000637	0010000640	0010000638	0010000639
0.5 – 20 l	0.5 – 20 l	0.5 – 15 l	0.25 – 10 l
45 mm	45 mm	45 mm	45 mm
36 mm	38 mm	40.5 mm	40 mm
0.5 mm	0.5 mm	0.25 mm	0.5 mm
70 / 260 mm	70 / 260 mm	70 / 250 mm	70 / 250 mm
300 mm	300 mm	300 mm	290 mm
1 mbar	1 mbar	1 mbar	1 mbar
6 bar	6 bar	6 bar	6 bar
FFPM / SIC, AISI 316L	FFPM / SIC, AISI 316L	FFPM / SIC, AISI 316L	FFPM / SIC, AISI 316L
2 – 13	2 – 13	2 – 13	2 – 13
yes	yes	yes	yes
180 °C	110 °C	180 °C	180 °C
wet chemical	wet chemical	wet chemical	wet chemical

	T 50 digital			
Dispersing element	S 50 N – G 45 G	S 50 N – G 45 M	S 50 N – G 45 F	S 50 N – G 45 G – ST
Ident. No.	0008003000	0008003300	0008003900	0008039500
Working range	0.5 – 20 l	0.5 – 15 l	0.25 – 10 l	0.5 – 20 l
Stator diameter	45 mm	45 mm	45 mm	45 mm
Rotor diameter	36 mm	40.5 mm	40 mm	36 mm
Gap between rotor and stator	0.5 mm	0.25 mm	0.5 mm	0.5 mm
Min. / max. immersion depth	70 / 250 mm	70 / 250 mm	70 / 250 mm	70 / 250 mm
Shaft length	300 mm	290 mm	290 mm	300 mm
Materials in contact with medium	PTFE, AISI 316L	PTFE, AISI 316L	PTFE, AISI 316L	PTFE, AISI 316L
pH range	2 – 13	2 – 13	2 – 13	2 – 13
Suitable for solvents	yes	yes	yes	yes
Max. temperature	180 °C	180 °C	180 °C	180 °C
Sterilization methods	all methods	all methods	all methods	all methods

	T 50 digital			
Dispersing element	S 50 B – G 45 G	S 50 B – G 45 G – ST	S 50 B – G 45 M	S 50 B – G 45 F
Ident. No.	0010000633	0010000636	0010000634	0010000635
Working range	0.5 – 20 l	0.5 – 15 l	0.5 – 15 l	0.25 – 10 l
Stator diameter	45 mm	45 mm	45 mm	45 mm
Rotor diameter	36 mm	38 mm	40.5 mm	40 mm
Gap between rotor and stator	0.5 mm	0.5 mm	0.25 mm	0.5 mm
Min. / max. immersion depth	70 – 250 mm	70 – 250 mm	70 – 250 mm	70 – 250 mm
Shaft length	300 mm	300 mm	300 mm	300 mm
Materials in contact with medium	AISI 316L, bronze	AISI 316L, bronze	AISI 316L, bronze	AISI 316L, bronze
pH range	2 – 13	2 – 13	2 – 13	2 – 13
Suitable for solvents	yes	yes	yes	yes
Max. temperature	180 °C	180 °C	180 °C	180 °C
Sterilization methods	all methods	all methods	all methods	all methods

23

24

25

Dispersing tools



Dispersing element
Ident. No.
Working range
Stator diameter
Rotor diameter
Gap between rotor and stator
Min. / max. immersion depth
Shaft length
Materials in contact with medium
pH range
Suitable for solvents
Max. temperature
Sterilization methods
Min. vacuum

Dispersing element
Ident. No.
Working range
Max. circumferential speed
Max. permissible rotor diameter
Material
Generator diameter
Min. / max. immersion depth
Available seals

Dispersing element
Ident. No.
Working range
Stator diameter
Rotor diameter
Gap between rotor and stator
Min. / max. immersion depth
Shaft length
Materials in contact with medium
pH range
Suitable for solvents
Max. temperature
Sterilization methods
Min. vacuum
Max. pressure

T 50 digital			
S 50 KR – G 45 G	S 50 KR – G 45 G – ST	S 50 KR – G 45 M	S 50 KR – G 45 F
0010000629	0010000632	0010000630	0010000631
0.5 – 20 l	0.5 – 20 l	0.5 – 15 l	0.25 – 10 l
45 mm	45 mm	45 mm	45 mm
36 mm	38 mm	40.5 mm	40 mm
0.5 mm	0.5 mm	0.25 mm	0.5 mm
70 – 260 mm	70 – 260 mm	70 – 260 mm	70 – 260 mm
300 mm	300 mm	300 mm	300 mm
PTFE, AISI 316L	PTFE, AISI 316L	PTFE, AISI 316L	PTFE, AISI 316L
2 – 13	2 – 13	2 – 13	2 – 13
no	no	no	no
110 °C	110 °C	110 °C	110 °C
wet chemical	wet chemical	wet chemical	wet chemical
100 mbar	100 mbar	100 mbar	100 mbar

T 50 digital		
R 50 "high speed" stirring shaft	S 50 N – W 65 SK Cutting head	S 50 N – W 80 SMK Jet mixer head
0001689300*	0008005100	0008006300
0.25 – 30 l	1 – 10 l	1 – 50 l
15.7 – 23 m/s	–	–
50 mm	–	–
Stainless steel (AISI 316L)	–	–
–	65 mm	80 mm
–	80 / 350 mm	140 / 350 mm
–	S 50 N	S 50 N

* Included with delivery:
R 1402 Dissolver
Ident. No. 0001243300

T 65 basic I digital		
S 65 KG – HH – G 65 G	S 65 KG – HH – G 65 M	S 65 KG – HH – G 65 F
0008005500	0008005700	0008005900
2 – 50 l	2 – 40 l	2 – 30 l
65 mm	65 mm	65 mm
58 mm	58 mm	58 mm
0.5 mm	0.5 mm	0.5 mm
90 / 450 mm	80 / 450 mm	80 / 450 mm
520 mm	510 mm	500 mm
FFPM / SIC, AISI 316L	FFPM / SIC, AISI 316L	FFPM / SIC, AISI 316L
2 – 13	2 – 13	2 – 13
yes	yes	yes
180 °C	180 °C	180 °C
wet chemical	wet chemical	wet chemical
1 mbar	1 mbar	1 mbar
6 bar	6 bar	6 bar

Dispersing tools



	T 65 basic digital		
Dispersing element	S 65 KR – G 65 G	S 65 KR – G 65 M	S 65 KR – G 65 F
Ident. No.	0010000641	0010000642	0010000643
Working range	2 – 50 l	2 – 40 l	2 – 30 l
Stator diameter	65 mm	65 mm	65 mm
Rotor diameter	53 mm	58 mm	58 mm
Gap between rotor and stator	0.5 mm	0.5 mm	0.5 mm
Min. / max. immersion depth	90 – 450 mm	80 – 450 mm	80 – 450 mm
Shaft length	520 mm	520 mm	520 mm
Materials in contact with medium	PTFE, AISI 316L	PTFE, AISI 316L	PTFE, AISI 316L
pH range	2 – 13	2 – 13	2 – 13
Suitable for solvents	no	no	no
Max. temperature	80 °C	80 °C	80 °C
Sterilization methods	wet chemical	wet chemical	wet chemical
Min. vacuum	100 mbar	100 mbar	100 mbar

For dispersing instrument	Dispersing element Shaft / Agitator shaft	With seal or bearing type*	Generator or element**	With outer diameter (mm)	Degree of fineness achieved***
T 10 basic	S 10	N	–	5 / 8 / 10	G
T 18 digital	S 18	N	–	10 / 19	G
T 25 digital	S 25	N / KV / NK / KR	–	8 / 10 / 18 / 19 / 25	G / F
T 50 digital	S / R 50	N / B / KR	G / W	45 / 65 / 80	G / M / F
T 65 basic	S 65	KG – HH / KR	G	65	G / M / F
T 65 digital	S 65	KG – HH / KR	G	65	G / M / F

- * N = PTFE bearing
- KV = Ball bearing with vacuum-tight sliding-ring seal with silicon carbide seal rings
- NK = PTFE bearing with additional ball bearing without seal
- KG – HH = Ball bearing with sliding-ring seals of hard metal allow with FPM seals rings
- B = Bronze bearing
- KR = Ball bearing with FKM or FPM seal
- ** G = Proved configuration
- W = Special element
- *** G = Coarse
- M = Medium
- F = Fine

magic LAB®



magic LAB®



Materials in contact with medium made of stainless steel



7 interchangeable modules available



Handy transport box with integrated power supply included in delivery

magic LAB® with module UTL

magic LAB®

Technical data

Motor power	900 W
Speed range (40 m/s)	3000 – 26,000 rpm
Operating voltage	220 – 240 V
Frequency	50 – 60 Hz
Process pressure	up to 2.5 bar
Product temperature in continuous operation	up to 80 °C
In short time operation (up to 18 min/h)	up to 120 °C
Materials in contact with the medium	Stainless steel (AISI 316L and AISI 316Ti)
Sealing material	PTFE-compound
Shaft sealing ring	Standard FPM
Elastomers in the working chamber	optional EPDM (FDA), FFPM
Dimensions (W x D x H)	170 x 270 x 215 mm

Ident. No. U078310

magic LAB®

- > Suitable for a wide range of applications
- > Ideal for inline, circulating and classical batch processing
- > Safe scale-up due to many constant work parameters
- > Modular construction
- > Simple heating and cooling of all modules
- > Easy and quick exchange of the modules
- > With rotor-stator systems operating at circumferential speeds up to 40 m/s



Multifunction storage and transportation box

One machine for many mixing tasks

The magic LAB® is a unique and multi-functional small-scale laboratory machine. It is designed for mixing, dispersing, wet milling and incorporation of powders into liquids.

The magic LAB® is most frequently used for the development of new products or for optimizing of existing process techniques, particularly in the chemical, cosmetic, pharmaceutical and food industries. It is an ideal machine for continuous, circulating and batch processing with interchangeable modules.





magic LAB® with module UTC
Dispersing/mixing in batch operation



CMS Periphery
The integrated solution for wetting of most difficult powders



1 l module Micro-Plant
with exchangeable modules (UTL / DR / MK / MKO)



2 l module Micro-Plant
with exchangeable modules (UTL / DR / MK / MKO)



Three-stage dispersing for manufacturing of fine emulsions and suspensions.



Wet-milling by means of spiral gearing milling tool. Production of colloidal solutions. Adjustable flow rate and friction by setting the gap between the rotor and stator.



Wet-milling as with the MK-module. The cones are furnished with an abrasion-resistant tungsten carbide-cobalt coating. Narrowest grinding gap enables producing of even finer suspensions.



Suction of solids into fluids in the recirculation process. Free from lumps and dust processing of powders and granules. Energy-efficient homogeneous mixing.



Continuous mixing and dispersion of powders in liquids. Patented process. Fast and homogeneous mixing in only one passage, avoiding agglomerates. Solids content up to 80%.

Technical data

Flow rate	80 l/h (H ₂ O)	200 l/h (H ₂ O)**
Standard rotational speed	14,600 rpm	14,600 rpm
Circumferential speed	23 m/s	23 m/s*

Ident. No. U078352

Ident. No. U076662

Module Cone mill MKO

25 l/h (H ₂ O)**
14,600 rpm
23 m/s*

Ident. No. U079664

Module CMS

1000 l/h (H ₂ O)**
11,000 rpm
19.5 m/s*

Ident. No. U075333

Module MHD (mixing, homogenising, dispersing)

60 l/h (H ₂ O)**
14,600 rpm
23 m/s*

Ident. No. U075256

* At standard rotational speed and 50 Hz
** at minimal gap between the rotor and stator

Mills



IKA® introduces the world's first disposable grinding system for safe, instant and precise milling results. The disposable grinding chamber eliminates the possibility of cross-contamination and saves cleaning costs and time. Convenient to use while assuring high safety and reproducibility to cover a broad range of applications. One can also use dry ice to cool the sample. The Tube Mill control is patented, designed and manufactured exclusively by IKA®.



World's first!

- > Disposable grinding chamber
- > Stops cross-contamination
- > No cleaning required
- > Perfect milling results
- > Large application range

Patented



Tube Mill control



Dust-proof sealed housing
High level of user safety



Clearly arranged, multi-lingual OLED display, Error code display



Adjustable safety speed and time



USB interface to control and document all the parameters and for updating your firmware



reddot design award
winner 2013

Mills

World's first



reddot design award winner 2013



Watch the video:
www.ika.com/video



100 ml chamber coming soon.
Please contact your IKA® representative for further information

Technical data

	Tube Mill control
Motor rating input / output	100 / 80 W
Speed range	5000 – 25,000 rpm
Useful volume	40 ml
Duty cycle (ON / OFF)	5 s – 3 min (timer)
Circumferential speed	65 m/s
Max. feed hardness	5 Mohs
Max. feed grain size	10 mm
Grinding chamber material	Transparent plastic (PP)
Dimensions (W x D x H)	180 x 300 x 170 mm
Weight	2.7 kg
Permissible relative moisture	80%
Protection class acc. to DIN EN 60529	IP 30

Ident. No. 0004180000*

* Two single grinding chambers are included in the delivery



Disposable grinding chamber, 40 ml

	Ident. No.
MT 40.10	0004425000
Disposable grinding chamber 40 ml (10 pieces/pack)	
MT 40.100	0020001173
Disposable grinding chamber 40 ml (100 pieces/pack)	
MTC 40.100	0020001182
Cover for MT 40	
MT 40.10 steril	0020001984
Disposable grinding chamber steril 40 ml (10 pieces)	
MT 40.100 steril	0020001985
Disposable grinding chamber steril 40 ml (100 pieces)	

Multiple grinding chamber, 40 ml

	Ident. No.
MMT 40.1	0020003165
MMT 40.1 Stainless Steel package, includes 1 MMT 40 chamber, 25 sealings, 5 beaters, 5 couplings	
A-MMT 40.100	0020003378
A-MMT 40.100 Abrasion Set Spare Parts, includes 100 sealings, 10 beaters, 10 couplings	



Quiet operation



Adjustable safety speed and time



Tube Mill control



Dust-proof sealed housing
High level of user safety



Clearly arranged, multi-lingual OLED display, Error code display



Interval operation available
Easy operation with touch keypad



USB interface to control and document all the parameters and for updating your firmware

Cross-contamination free
No cleaning required
Precise milling results
Large application range



Mills

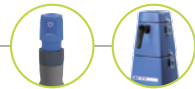

M 20



Removable, easy-to-clean,
high-grade steel chamber



Double-walled grinding
chamber

NEW
Q3/2015



A 11
basic



Quiet operation



Easily exchangeable
beater / cutter



Technical data

	A 10 basic	A 11 basic	M 20 Universal mill
Motor rating input/output	300 / 240 W	160 / 100 W	620 / 260 W
Speed range	25,000 rpm (fixed)	28,000 rpm (fixed)	20,000 rpm (fixed)
Useful volume	50 ml	80 ml (optional 250 ml)	250 ml
Duty cycle (ON / OFF)	5 / 10 min	1 / 10 min	7 / 10 min
Overload protection	yes	yes	yes
Circumferential speed	72 m/s	53 m/s	72 m/s
Max. feed hardness	5 Mohs*	6 Mohs*	5 Mohs*
Max. feed grain size	6 mm	10 mm	7 mm
Grinding chamber material	stainless steel (AISI 14301)	stainless steel (AISI 316L)	stainless steel (AISI 316L)
Dimensions (W x D x H)	130 x 145 x 250 mm	85 x 85 x 240 mm	170 x 170 x 350 mm
Weight	2.9 kg	1.5 kg	6.6 kg
Permissible ambient temperature	5 – 40 °C	5 – 40 °C	5 – 40 °C
Permissible relative moisture	80%	80%	80%
Protection class acc. to DIN EN 60529	IP 21	IP 43	IP 21
	Ident. No. 0004020700**	Ident. No. 0002900000	Ident. No. 0001603600

* 9 Mohs with accessory beater/cutter M 22, A 10.3 or A 11.3

** A 10.1 and A 10.4 included in the delivery of all A 10 basic



Universal mill | Microfine grinder

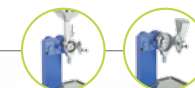

MF 10.1
Cutting-grinding head
MF 10.2
Impact-grinding head

Technical data	MF 10 basic
Motor rating input/output	1000 / 500 W
Speed range	3000 – 6500 rpm
Speed display	no
Useful volume	max. 5 kg/h
Duty cycle (ON / OFF)	120 / 30 min
Overload protection	yes
Circumferential speed	22.5 m/s
Max. feed hardness	6 Mohs
Max. feed grain size	15 mm
Grinding chamber material	stainless steel (AISI 304)
Dimensions (W x D x H)	320 x 300 x 560 mm
Weight	11.9 kg (incl. MF 10.1)
Permissible ambient temperature	5 – 40 °C
Permissible relative moisture	80%
Protection class acc. to DIN EN 60529	IP 22

Technical data	
Circumferential speed	22.5 m/s 31.4 m/s
Max. granularity of task	max. 15 mm max. 10 mm
Dimensions including MF 10 basic	320 x 300 x 560 mm 320 x 300 x 450 mm
Weight including MF 10 basic	11.9 kg 12.4 kg
Materials in contact with medium	stainless steel

- 1 MF 10.1
Cutting-grinding head
Ident. No. 0002870900
- 2 MF 10.2
Impact-grinding head
Ident. No. 0002871000

Ident. No. 0002836000

MF 10 basic



Easily interchangeable heads



Easy to clean working surface made of stainless steel



Powerful drive

Powerful



Mills | Accessories

A 10 basic accessories

	Ident. No.
A 10.1	0025001680
Stainless steel cutter	
A 10.2	0025001162
Star-shaped cutter	
A 10.3	0025001161
Hard metal cutter	
A 10.4	0025001664
Grinding chamber reduction	



A 11 basic accessories

	Ident. No.
A 11.1	0002904600
Spare beater, stainless steel	
A 11.2	0002905200
Cutting blade, stainless steel	
A 11.3	0002983000
Beater, stainless steel, coated with chromium carbide	
A 11.4	0002904100
Grinding chamber, polycarbonate, 250 ml	
A 11.5	0002983100
Spare grinding chamber, Tefcel, 80 ml	
A 11.6	0003302900
Double beater, titanium	
A 11.7	0003048700
Funnel, jacket PTFE, sieve stainless steel	



MF 10 basic accessories

	Ident. No.
MF 0.25	0002938900
Sieve, Ø 0.25 mm	
MF 0.5	0002939000
Sieve, Ø 0.5 mm	
MF 1.0	0002939200
Sieve, Ø 1 mm	
MF 2.0	0002939400
Sieve, Ø 2 mm	
MF 3.0	0002939500
Sieve, Ø 3 mm	
MF 4.0	0002939600
Sieve, Ø 4 mm	

M 20 accessories

	Ident. No.
M 21	0000328200
Spare cutter, stainless steel	
M 22	0000521800
Hard metal cutter, tungsten carbide	
M 23	0001443400
Star-shaped cutter, stainless steel	
M 20.1	0008006200
Grinding chamber, 250 ml	



Universal mill | Pilotina

IKA® +

The IKA® Pilotina can be used for a great variety of milling functions in a diverse range of industrial tasks.



The universal 2 in 1 mill for dry products



The cutting mill system
The preeminent choice for the disintegration of smooth, sticky, elastic or fibrous materials.



The impact milling system
The foremost option for the disintegration of hard and brittle materials.

Technical data	Pilotina MU	Pilotina MC	Pilotina MI
Motor power	3 kW	1.5 kW	1.5 kW
Speed range	1500 – 4500 rpm	1500 rpm	3000 rpm
Speed indication	digital	no	no
Capacity (depending on the final fineness)	approx. 60 – 80 kg/h	approx. 60 kg/h	approx. 80 kg/h
Overload protection	yes	yes	yes
Circumferential speed	9 – 34 m/s	9 m/s	22 m/s
Max. charging hardness	3 or 6 Mohs	3 Mohs	6 Mohs
Approx. max. charging size	65 x 60 or 25 mm	65 x 60 mm	25 mm
Dimensions, approx. (L x W x H)	485 x 575 x 700 mm	485 x 575 x 700 mm	485 x 575 x 630 mm
Weight, approx.	80 kg	70 kg	70 kg
Protection type	IP 55	IP 55	IP 55
	Ident. No. U105421	Ident. No. U106466	Ident. No. U106465



Pilotina



Easily interchangeable funnels



Easy conversion from a cutting mill to an impact mill



Circumferential speed adjustable to requirements of the milling process



Safe design of inlet and outlet

Universal 2 in 1 Mill for dry products

The IKA® Pilotina is a dry milling system in pilot plant scale, available in 3 different configurations. The modular design allows an easy modification from impact to cutting mill and vice versa within shortest time. Your advantage: one machine, two milling principles, all this without making any compromise regarding disintegration quality. Due to the powerful, frequency controlled 3 kW drive with digital indication the circumferential speed of the tool can be adjusted to the required milling process in an optimum way.

Dry Block Heaters



IKA® has a diverse range of dry block heaters designed to accommodate various interchangeable heating blocks. They provide precise temperature control for reproducible results. These digital block heaters are ideal for melting and boiling point determination, enzyme reactions, incubation and activation of cultures, immunoassays, DNA denaturation, culture media tests, coagulation tests, blood urea- nitrogen determinations and in situ hybridizations.



Precise temperature control!

- > Bushing acc. to DIN 12878
- > Rapid heat up rates
- > Exceptional temperature uniformity
- > PT 1000.60 temperature sensor included in the delivery



Dry Block Heater 3



Temperature display for the actual/set-point temperatures, up/down arrows for set-point control



A wide range of interchangeable heating blocks to fit any sample tube or plate



External probe for accurate temperature control



Timer display for accurate and reproducible conditions, up/down arrows for set-point control

Dry Block Heaters

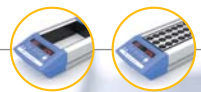

IKA® dry block heaters are highly versatile suitable for broad range of applications.

- > DNA extractions
- > DNA analysis
- > Melting point determination
- > Boiling point determination
- > Immunoassays
- > Enzyme reactions
- > Enzymatic processes
- > Enzyme activity studies
- > In situ hybridization
- > Blood-urea-nitrogen determinations
- > Nucleic acid hybridization
- > Coagulation studies
- > Biochemical processes
- > Incubation and activation of cultures
- > Blood examinations
- > Fertile ground processing
- > Restriction digest
- > Denaturation



Technical data	Dry Block Heater 1	Dry Block Heater 2
Number of blocks	1	2
Heat output	165 W	250 W
Heating temperature range	RT +5 °C to 120 °C	RT +5 °C to 120 °C
Display	LED	LED
Heat control accuracy	± 1 K	± 1 K
Connection for external temperature sensor	DIN 12878	DIN 12878
Control accuracy with sensor	± 1 K	± 1 K
Material of the blocks	aluminum alloy	aluminum alloy
Timer	1 min to 99h 59min	1 min to 99h 59min
Dimensions (W x D x H)	151 x 228 x 73 mm	151 x 304 x 73 mm
	Ident. No. 0004025100*	Ident. No. 0004025200*

IKA+

PT 1000.60 temperature sensor included in the delivery.



Dry Block Heater 3	Dry Block Heater 4
3	4
330 W	412 W
RT +5 °C to 120 °C	RT +5 °C to 120 °C
LED	LED
± 1 K	± 1 K
DIN 12878	DIN 12878
± 1 K	± 1 K
aluminum alloy	aluminum alloy
1 min to 99h 59min	1 min to 99h 59min
151 x 380 x 73 mm	151 x 456 x 73 mm
Ident. No. 0004025300*	Ident. No. 0004025400*

* PT 1000.60 Temperature sensor included in the delivery of all the Dry Block Heaters

Dry Block Heaters

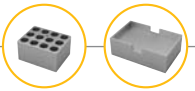

Single blocks (95 x 76 x 51)

Micro centrifuge tubes

- DB 1.1 Single block, PCR tubes, 0.5 ml
- DB 1.2 Single block, Eppendorf tubes, 1.5 ml
- DB 1.3 Single block, Microtubes, 1.5 ml
- DB 1.4 Single block, Eppendorf tubes, 2.0 ml
- DB 1.5 Single block, Corning tubes, 2.0 ml

Conical bottom centrifuge tubes

- DB 2.1 Single block, Conical tubes, 15 ml
- DB 2.2 Single block, Conical tubes, 50 ml

Combination blocks

- DB 3.1 Single block, test tube combination, 6 / 12 / 13 / 25 mm
- DB 3.2 Single block, centrifuge combination, 1.5 / 15 / 50 ml
- DB 3.3 Single block, microtube combination, 0.5 / 1.5 / 2 ml

Standard test tubes

- DB 4.1 Single block, Round tubes, 6 mm
- DB 4.2 Single block, Round tubes, 10 mm
- DB 4.3 Single block, Round tubes, 12 / 13 mm
- DB 4.4 Single block, Round tubes, 12 / 13 mm
- DB 4.5 Single block, Round tubes, 15 / 16 mm
- DB 4.6 Single block, Round tubes, 20 mm
- DB 4.7 Single block, Round tubes, 25 mm
- DB 4.8 Single block, Round tubes, 35 mm
- DB 4.9 Single block, Round tubes, 17 / 18 mm

Vials

- DB 5.1 Single block, 12 mm vials
- DB 5.2 Single block, 15 mm vials
- DB 5.3 Single block, 17 mm vials
- DB 5.4 Single block, 19 mm vials
- DB 5.5 Single block, 21 mm vials
- DB 5.6 Single block, 23 mm vials
- DB 5.7 Single block, 25 mm vials
- DB 5.8 Single block, 28 mm vials
- DB 5.9 Single block, 16 mm vials

PCR - plates, tubes, strips

- DB 6.1 Single block, 10 x 8 PCR tube strips, 0.2 ml tubes
- DB 6.2 Single block, 64 PCR tubes, 0.2 ml tubes
- DB 6.3 Double block, 1 x 96-well PCR plate, 0.2 ml tubes

Cuvettes

- DB 8.1 Single block, 2 x 6 cuvettes, 12.5 mm

Double block (95 x 152 x 57)

Microtitre plates

- DB 7.1 Double block, 96- or 384-Well-Platte

Temperature sensors

- PT 1000.60
- PT 1000.90

	Holes ø	No. of holes	Hole depth (mm)	Ident. No.
	Ø 7.9 mm	30	27.6	0004467600
	Ø 11.5 mm	20	36.9	0004467700
	Ø 11.1 mm	20	39.1	0004467800
	Ø 11.5 mm	20	38.1	0004467900
	Ø 10.9 mm	20	38.1	0004468000
	Ø 17.1 mm	12	44.5	0004468100
	Ø 29.0 mm	5	47.6	0004468200
	Ø 8.3 / Ø 13.9 / Ø 26.2 mm	6 / 5 / 3	48.4 / 48.4 / 48.4	0004468300
	Ø 11.1 / Ø 17.1 / Ø 29.0 mm	4 / 3 / 2	39.1 / 44.5 / 47.6	0004468400
	Ø 7.9 / Ø 11.1 / Ø 11.5 mm	6 / 10 / 5	27.6 / 39.1 / 38.1	0004468500
	Ø 8.3 mm	30	48.4	0004468600
	Ø 10.7 mm	24	48.4	0004468700
	Ø 13.9 mm	16	48.4	0004468800
	Ø 13.9 mm	20	48.4	0004468900
	Ø 17.5 mm	12	48.4	0004469000
	Ø 21 mm	8	48.4	0004469100
	Ø 26.2 mm	6	48.4	0004469200
	Ø 35 mm	4	47.6	0004469300
	Ø 19.1 mm	12	48.4	0004469400
	Ø 12.7 mm	20	30.0	0004469500
	Ø 15.8 mm	20	35.0	0004469600
	Ø 17.8 mm	12	45.0	0004469700
	Ø 19.7 mm	12	45.0	0004469800
	Ø 21.7 mm	9	45.0	0004469900
	Ø 23.8 mm	8	45.0	0004470000
	Ø 25.8 mm	8	45.0	0004470100
	Ø 28.8 mm	6	45.0	0004470200
	Ø 16.4 mm	15	45.0	0004470300
	Ø 6.4 mm	80	15.5	0004470400
	Ø 6.4 mm	64	20.2	0004470500
	Ø 6.4 mm	96	15.5	0004470600
			25.4	0004470700
	Holes ø	No. of holes	Hole depth (mm)	Ident. No.
	–	–	13.5	0004470800

	Ident. No.
Temperature sensor, stainless steel, Ø 3 mm	0003516800
Temperature sensor, stainless steel, coated with SafeCoat, Ø 3 mm	0004480600

Hotplates



IKA® hotplates allow for safe heating and tempering. The set-up plate is made from glass ceramics that ensures the best possible chemical resistance. The hotplates offer a high level of safety due to a fixed safety circuit, the Hot Top indicator, and the error code display. An electronic temperature sensor may be connected for precise temperature control.



**C-MAG
HP 7**



Elevated control panel
for protection against
spilled liquids



Hot top indicator
to prevent burns



LED digital display
for precise temperature
setting



Ceramic set-up plate offers
excellent chemical resistance
to acid, bases and solvents



	C-MAG HP 4	C-MAG HP 7	C-MAG HP 10
Technical data			
Temperature display	digital	digital	digital
Heat output	250 W	1000 W	1500 W
Heating rate	2.5 K/min	5 K/min	5 K/min
Temperature range	50 – 500 °C	50 – 500 °C	50 – 500 °C
Setting accuracy	± 5 K	± 5 K	± 5 K
Safety circuit fixed	550 °C	550 °C	550 °C
Control accuracy with sensor	–	ETS-D5 / ± 0.5 K	ETS-D5 / ± 0.5 K
Heating plate material	glass ceramic	glass ceramic	glass ceramic
Weight	3 kg	5 kg	6 kg
Dimensions (W x D x H)	150 x 260 x 105 mm	220 x 330 x 105 mm	300 x 415 x 105 mm
	Ident. No. 0003581600	Ident. No. 0003581800	Ident. No. 0003582000

Heating baths



IKA® heating baths are developed with a strong focus on safety. All baths are equipped with a double jacket to protect against burns and a safety temperature monitor keeps the bath from over heating. After turning on the unit every time, the safety functions are automatically checked.



HB10
With locking function

HB 10



LCD digital display
for precise temperature setting



Key-button with locking function for the heating bath temperature



Integrated ergonomic carrying handles



Technical data	HB 10	HBR 4 digital
Heat output	1300 W	1000 W
Temperature range	RT – 180 °C	RT – 200 °C
Setting tolerance	± 1 K	± 1 K
Deviation (3 l H ₂ O, 90 °C)	± 1 K	± 1 K
Temperature display	digital	digital
Volume	3 L	5 L
Safety class acc. to DIN 12877	2	2
Adjustable safety circuit min / max	50 °C / 190 °C	–
Material	stainless steel 1.4301	stainless steel (AISI 304)
Weight	3 kg	4.4 kg
Dimensions (W x D x H)	290 x 190 x 265 mm	–
	Ident. No. 0004068000	Ident. No. 0002602300

HBR 4 digital accessories

	Ident. No.
H 240	0002858700
Ring set	
H 159	0001809700
Intermediate bottom	



Temperature control

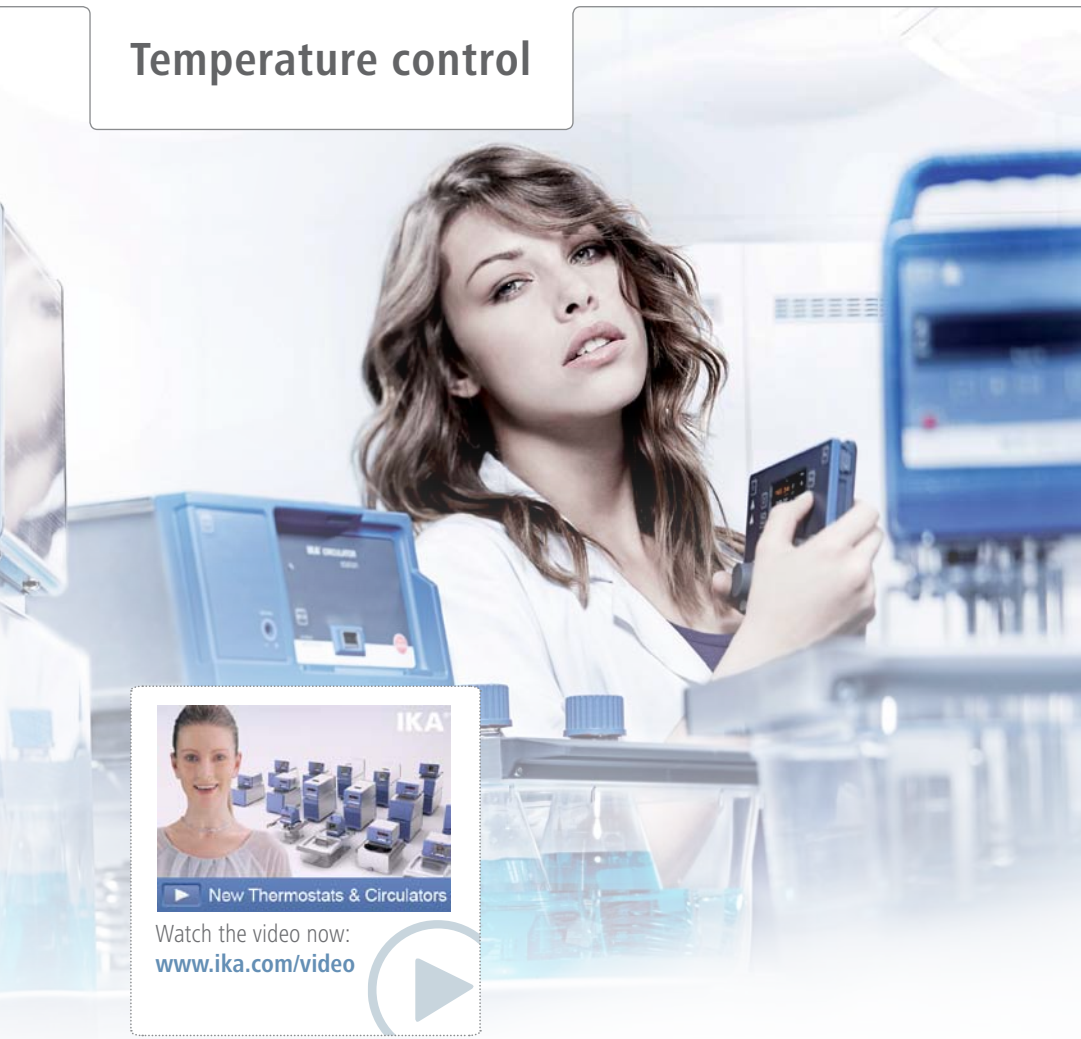

New Thermostats & Circulators

Watch the video now:
www.ika.com/video

IKA® temperature control systems ensure the safe and precise temperature control of liquids. The immersion circulators temper liquids up to 100° C. Able to withstand a powerful heat output of 1500 W, IKA® circulators are safe to use with all standard bath vessels. The products control the temperature from 28 to 300° C and are fully geared towards safety and comfort. Intelligent features of the immersion and heating bath circulators include: plug & play technology, digital display, easy control, set point limiting, and a visual/ acoustic alarm.

Highly powerful bridge thermostats!

- > Temperature range: RT – 250 °C
- > Powerful pressure / suction pump
- > Adjustable safety circuit

IC control



Integrated pressure / suction pump allows flexibility for internal and external applications



Flexible bath bridge enables easy mounting on different water bath sizes



Large easy-to-read TFT display



Removable wireless controller (WiCo) for easy and safe operation up to 10 m



Removable wireless controller (WiCo) for convenient and user-friendly operation!



Temperature control

Thermostats control | Packages



Technical data

	ICC basic control	IC basic control
Appliance type	Compact immersion circulator	Immersion circulator
Heater capacity (230 / 115 V)	2000 / 1000 W	2500 / 1200 W
Temperature range	RT +10°C – 150 °C RT +10°C – 150 °C (20 °C with cooling coil*)	RT +10°C – 200 °C RT +10°C – 250 °C (20 °C with cooling coil*)
Temperature display	LED TFT	LED TFT
Temperature stability DIN 12876	± 0.02 K ± 0.01 K	± 0.02 K ± 0.01 K
Bath volume range	depends on used bath	depends on used bath
Max. flow rate (at 0 bar)	18 l/min	26 l/min 31 l/min
Max. pump pressure	0.3 bar	0.45 bar 0.61 bar
Min. suction pressure	0.2 bar	0.35 bar 0.45 bar
Dimensions (W x D x H)	147 x 158 x 340 mm	245 x 260 x 300 mm
USB interface	yes	yes
	Ident. No. 0004134400 Ident. No. 0004136600	Ident. No. 0003861000 Ident. No. 0003863000**

Description	Package name	Ident. No.
Open heating bath circulator	ICC basic eco 8*	0008034900
	ICC basic pro 9	0008035100
	ICC basic eco 18*	0008035000
	ICC basic pro 12	0010000414
	ICC basic pro 20	0008035200
Open heating bath circulator	ICC control eco 8*	0008035300
	ICC control pro 9	0008035500
	ICC control eco 18*	0008035400
	ICC control pro 12	0010000415
	ICC control pro 20	0008035600
Open heating bath circulator with cover**	ICC basic eco 8 c*	0008035700
	ICC basic pro 9 c	0008035900
	ICC basic eco 18 c*	0008035800
	ICC basic pro 12 c	0010000416
Open heating bath circulator with cover**	ICC basic pro 20 c	0008036000
	ICC control eco 8 c*	0008036100
	ICC control pro 9 c	0008036300
	ICC control eco 18 c*	0008036200
Open heating bath circulator with cover**	ICC control pro 12 c	0010000417
	ICC control pro 20 c	0008036400
	IC basic eco 18 c*	0008036600
Open heating bath circulator with cover	IC basic pro 12 c	0008039900
	IC basic pro 20 c	0008036800
	IC control eco 18 c*	0008037000
Open heating bath circulator with cover	IC control pro 12 c	0008040000
	IC control pro 20 c	0008037200

* Lower working temperatures possible with connection to a chiller
 ** PT 100.30 and CC 1 Cooling Coil included in delivery

* Maximum Temperature 100 °C
 ** PT 100.30 and CC 1 Cooling Coil included in delivery

Temperature control



	HBC 5 basic control	HBC 10 basic control	RC 2 basic control
Technical data			
Appliance type	Heating bath circulator	Heating bath circulator	Recirculating chiller
Safety class	III (FL)	III (FL)	I (FL)
Cooling capacity at 20°C	–	–	400 W
Heater capacity (230 / 115 V)	2500 / 1200 W	2500 / 1200 W	–
Temperature range	RT +10°C – 200 °C RT +10°C – 250 °C (with integrated cooling coil*)	RT +10°C – 200 °C RT +10°C – 250 °C (with integrated cooling coil*)	-20 °C – RT
Temperature display	LED TFT	LED TFT	LED TFT
Temperature stability DIN 12876	± 0.02 K ± 0.01 K	± 0.02 K ± 0.01 K	± 0.1 K ± 0.05 K
Bath volume range	5 – 7 l	8 – 11 l	1.4 – 4 l
Max. flow rate (at 0 bar)	26 l/min 31 l/min	26 l/min 31 l/min	18 l/min
Max. pump pressure	0.45 bar 0.61 bar	0.45 bar 0.61 bar	0.3 bar
Min. suction pressure	0.35 bar 0.45 bar	0.35 bar 0.45 bar	0.2 bar
Dimensions (W x D x H)	275 x 500 x 405 mm	275 x 510 x 455 mm	220 x 526 x 480 mm
Permissible ambient temperature	5 – 40 °C	5 – 40 °C	5 – 32 °C
Permissible relative moisture	80%	80%	80%
Protection class acc. to DIN EN 60529	IP 21	IP 21	IP 21
USB / RS 232 interface	yes	yes	yes
	Ident. No. 0004125000 Ident. No. 0004127000	Ident. No. 0004135000 Ident. No. 0004137000	Ident. No. 0004171000 Ident. No. 0004173000

* Lower working temperatures possible with connection to a chiller



EH 4 basic Immersion thermostat
EH 4.1 Bath vessel 5 l
EH 4.2 Bath vessel 11 l
EH 4.3 Bath vessel 18 l

EH 4 basic
Ident. No. 0003164000
EH 4.1 Bath vessel 5 l
Ident. No. 0003335000
EH 4.2 Bath vessel 11 l
Ident. No. 0003335100
EH 4.3 Bath vessel 18 l
Ident. No. 0003335200



HBC 5 control



Integrated pressure / suction pump allows flexibility for internal and external applications



Precise temperature stability ± 0.01 K



Removable **wireless controller (WiCo)** for easy and safe operation up to 10 m



Integrated handles for easy carrying



Optical and acoustic warning function e.g. for over heating

Temperature control | Accessories

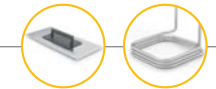

Accessories EH 4 Immersion circulator

	Ident. No.
EH 4 basic	0003164000
Immersion circulator	
EH 4.1	0003335000
Bath vessel, 5 l	
EH 4.2	0003335100
Bath vessel, 11 l	
EH 4.3	0003335200
Bath vessel, 18 l	

Accessories IC

	Ident. No.
5 CM.IC	0004577600
Cover, medium for IC, 12 l bath vessels	
6 CL.IC	0004471800
Cover, big for IC, 18/20 l bath vessels	
7 BS.IC	0004472800
Bridge, small for IC, 12/18/20 l bath vessels	
CC1	0020005116
Cooling coil for IC basic + control	

Accessories ICC

	Ident. No.
8 CS.ICC	0004471500
Cover, small for ICC, 8/9 l bath vessels	
9 CM.ICC	0025000290
Cover, medium for ICC, 12 l bath vessels	
10 CL.ICC	0004471600
Cover, big for ICC, 18/20 l bath vessels	
11 BS.ICC	0020003077
Bridge, small for ICC, 8/9 l bath vessels	
12 BL.ICC	0020003078
Bridge, big for ICC, 18/20 l bath vessels	
13 CC2	0025001061
Cooling coil for ICC	
14 PCS.ICC	0004471900
Pump connection set for ICC	



Bath vessel

	Ident. No.
1 IKA® IB eco 8*	0004248100
Bath vessel, plastic, 8 l, size S	
2 IKA® IB eco 18*	0004248200
Bath vessel, plastic, 18 l, size L	
3 IKA® IB pro 9	0004248500
Bath vessel, stainless steel, 9 l, size S	
IKA® IB pro 12	0004577500
Bath vessel, stainless steel, 12 l, size M	
4 IKA® IB pro 20	0004248600
Bath vessel, stainless steel, 20 l, size L	

* Maximum temperature 100 °C

Thermofluids

	Ident. No.
HF.Si.20.250.50A	0020003521
Heating fluid Si250A; 10 kg	
HF.Si.20.200.50	0020003520
Heating Fluid Si200; 10 kg	
UF.Si.N30.150.10LV	0020003518
Universal fluid Si150 LV; 9 kg	
CF.EG39.N30.80.22	0020003522
Cooling fluid EG30; 10.6 kg	
CF.EG100	0020004883
Cooling fluid EG 100%; 10.6 kg	

Soon available

Temperature control | Accessories

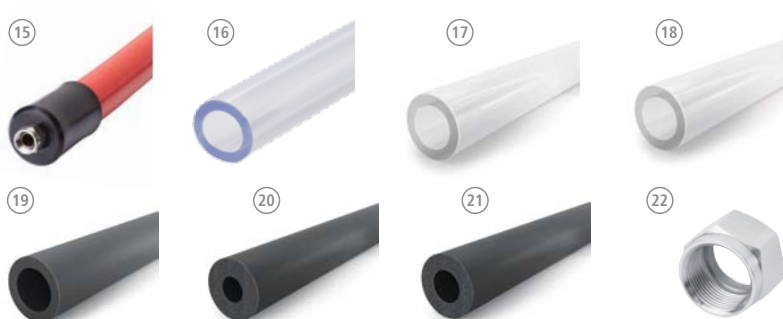

Hoses

	Ident. No.
15 LT 5.20	0002606700
Hose, insulated, stainless steel, Ø 10 mm, 150 mm, 2 pcs.	
LT 5.21	0020000988
Hose, insulated, PTFE, Ø 13 mm, 150 mm, 2 pcs.	
16 H.PVC.8	0004568800
Hose, PVC, Ø 8 mm, 150 mm, 2 pcs.	
H.PVC.12	0004568900
Hose, PVC, Ø 12 mm, 150 mm, 2 pcs.	
17 H.SI.8	0004569000
Hose, silicone, Ø 8 mm, 150 mm, 2 pcs.	
H.SI.12	0004569100
Hose, silicone, Ø 12 mm, 150 mm, 2 pcs.	
18 H.PUR.8.R	0020004612
Hose, PUR, Ø 8 mm, 150 mm, 2 pcs.	
H.PUR.12	0020004613
Hose, PUR, Ø 12 mm, 150 mm, 2 pcs.	
19 H.FKM.8	0004569200
Hose, FKM, Ø 8 mm, 150 mm, 2 pcs.	
H.FKM.12	0004569300
Hose, FKM, Ø 12 mm, 150 mm, 2 pcs.	

Insulation for hoses

	Ident. No.
20 ISO.8	0004569400
Insulation, Ø 8 mm	
21 ISO.12	0004569500
Insulation, Ø 12 mm	

Tube Racks

	Ident. No.
TubeRack.S. Type1.V4A.fit	0020004026
Stainless steel rack for bath size S, 57 x Ø 13 mm	
TubeRack.S. Type2V4A..fit	0020004027
Stainless steel rack for bath size S, 37 x Ø 17 mm	
TubeRack.S. Type3.V4A.fit	0020004028
Stainless steel rack for bath size S, 22 x Ø 22 mm	
TubeRack.L. Type1.V4A.fit	0020004029
Stainless steel rack for bath size L, 73 x Ø 13 mm	
TubeRack.L. Type2.V4A.fit	0020004030
Stainless steel rack for bath size L, 47 x Ø 17 mm	
TubeRack.L. Type3.V4A.fit	0020004031
Stainless steel rack for bath size L, 30 x Ø 22 mm	



Floating racks

	Ident. No.
Floating tube rack Type 1	0020003667
Floating tube rack for 24 x 1.5/2.0 ml tubes, 5 pcs.	
Floating tube rack Type 2	0020003668
Floating tube rack for 8 x 15 ml tubes, 5 pcs.	
Floating tube rack Type 3	0020003669
Floating tube rack for 4 x 50 ml tubes, 5 pcs.	

Magnetic valves

	Ident. No.
MV 1	0020003763
Magnetic valve for cooling water control Max. 100 °C	
CO V 1	0020000249
Closed pressure valve for external pump connection Set. Max. 180 °C	
22 Ball valve M 16 x 1	0020004620
Ball valve, complete open (M 16 x 1)	
Mechanic fluid level controller	0020004618
Mechanic fluid level controller	

Adapters

	Ident. No.
23 Elbow tube 90° Elbow tube 90°	0025001212
24 Olive for DN 6 hoses Olive for DN 6 hoses 2 pcs.	0020004667
25 Olive for DN 8 hoses Olive for DN 8 hoses 2 pcs.	0020004566
Olive for DN 12 hoses Olive for DN 12 hoses 2 pcs.	0020004889
Olive for DN 10 hoses Olive for DN 10 hoses 2 pcs.	0020004568
Adapter NPT 1/4 Adapter M 16 to NPT 1/4 2 pcs.	0020004569
Adapter NPT 1/2 Adapter M 16 to NPT 1/2 2 pcs.	0020004570
Adapter NPT 3/4 Adapter M 16 to NPT 3/4 2 pcs.	0020004571
Lock nut (2 pcs.) Lock nut 2 pcs.	0020004583
26 Stopper (2 pcs.) Stopper 2 pcs.	0020004584

Additional Accessories

	Ident. No.
WH10 WiCo holder	0020000984
27 PT 100.30 Temp. sensor, stn. steel	0004284700
Hollow balls, PP Hollow balls, PP, 500 pcs.	0020003666

Centrifuge



mini G



Integrated quick stop



Rotor exchangeable without tools



Adjustable digital timer



Quiet operation



Special safety features



Touch keypad for easy operation



Technical data

Capacity	8 x 2.0 ml
Permitted density	1.2 kg / dm ³
Centrifugal acceleration	2000 G
Max. kinetic energy	20 Nm
Motor rating input / output	12 / 8 W
Fixed speed	6000 rpm
Reversible direction of rotation	no
Dimensions (W x D x H)	155 x 175 x 105 mm
Weight	1.4 kg

mini G

Ident. No. 0003958000

IKA® micro centrifuge is ideal for applications which do not require ultra high speeds e.g., micro-filtrations and cell separations. The centrifuge features a compact design and a small footprint. A transparent lid allows for constant observation of the centrifuge which can be used with both microcentrifuge and PCR strip tubes. As a safety feature, the mini G will only operate when the lid is closed.



Accessories included in the delivery

	Ident. No.
1 Rotor 8 x 1.5 / 2 ml	0003918500
2 Rotor 4 x strip 8 x 0.2 ml	0004531300
3 Adapter set 0.5 ml x 8	0004470900
4 Adapter set 0.4 ml x 8	0004470901
5 Adapter set 0.2 ml x 8	0004470902

Rotary Evaporators



MAGIC DISTILLATION

Watch the video now:
www.ika.com/video



IKA® rotary evaporators set new standards for safety, efficiency and ease of use. These products offer excellent distilling solutions. All IKA® RV 10 evaporators are equipped with an automated lift including a safety stop function. More safety features are: interval operation, smooth start, end position recognition, automated lift-out in case of power outage as well as a timer function.



Efficient & safe distillation!

- > Automated management of cooling water
- > Automated venting after process end
- > Automated management of Heating bath controls

IKA® Patent
 Volume controlled distillation!

RV 10 control

240
 58.4 °C

Two digital displays for an optimal overview



Compatible with the complete range of IKA® RV 10 glassware



Can be moved by 140 mm to accommodate different flasks



Adjustable immersion angle and height





Rotary Evaporators

Best-in-class cooling surface 1500 cm²



V: Rotary evaporator with set of vertical glassware
V-C: Rotary evaporator with set of vertical coated glassware
FLEX: Rotary evaporator without any glassware (condenser, evaporation and receiving flask); either use pre-existing IKA® glassware or order separately
Dry Ice: Rotary evaporator with dry ice condenser glassware set

RV 8

Drive	
Motor type	brushless DC drive motor
Motor rating input	50 W
Speed range	5 – 300 rpm
Speed display	digital
Clockwise and counter-clockwise	no
Soft start	yes
Head angle adjustable	0 to 45°
Stroke displacement	120 mm, manual
Setting of lower end stop	no
Vacuum controller	optional

Motor type	brushless DC drive motor
Motor rating input	50 W
Speed range	5 – 300 rpm
Speed display	digital
Clockwise and counter-clockwise	no
Soft start	yes
Head angle adjustable	0 to 45°
Stroke displacement	120 mm, manual
Setting of lower end stop	no
Vacuum controller	optional

General data	
Dimensions (W x D x H)	510 x 345 x 490 mm
Weight of the drive incl. heating bath without glass parts	17.2 kg
Permissible ambient temperature	5 to 40 °C
Permissible relative moisture	80%
Protection class according to DIN EN 60529	IP 20
Voltage / Frequency	220 – 240 V / 50/60 Hz

Dimensions (W x D x H)	510 x 345 x 490 mm
Weight of the drive incl. heating bath without glass parts	17.2 kg
Permissible ambient temperature	5 to 40 °C
Permissible relative moisture	80%
Protection class according to DIN EN 60529	IP 20
Voltage / Frequency	220 – 240 V / 50/60 Hz

RV 8 V Ident. No. 0008033800
 RV 8 V-C Ident. No. 0008034200
 RV 8 FLEX Ident. No. 0008033400

The new RV 8 offers an effortless manual lifting mechanism. The ambidextrous design makes working more convenient and comfortable.



Compatible with the complete range of IKA® glassware



Adjustable immersion angle and height



Can be moved by 120 mm to accommodate different flasks



Heating bath can be used as a stand-alone unit and has integrated ergonomic carrying handles



Package details on page 162

Rotary Evaporators



MAGIC DISTILLATION

Watch the video now:
www.ika.com/video



V: Rotary evaporator with set of vertical glassware
V-C: Rotary evaporator with set of vertical coated glassware
FLEX: Rotary evaporator without any glassware (condenser, evaporation and receiving flask); either use pre-existing IKA® glassware or order separately
Dry Ice: Rotary evaporator with dry ice condenser glassware set

RV 10 digital

Drive

Motor type	brushless DC drive motor
Motor rating input	50 W
Speed range	20 – 280 rpm
Speed display	digital
Clockwise and counter-clockwise	yes
Soft start	yes
Head angle adjustable	0 to 45°
Stroke displacement	140 mm, motorized
Setting of lower end stop	60 mm, contact free
Vacuum controller	optional

General data

Dimensions (W x D x H)	530 x 410 x 430 mm
Weight of the drive incl. heating bath without glass parts	20 kg
Permissible ambient temperature	5 to 40 °C
Permissible relative moisture	80%
Protection class according to DIN EN 60529	IP 20
Voltage / Frequency	220 – 240 V / 50/60 Hz

RV 10 digital V Ident. No. 0008040300
 RV 10 digital V-C Ident. No. 0008040400
 RV 10 digital FLEX Ident. No. 0008040500

* RV 10.4002 Magnetic valve now included with delivery of every RV 10 control V, V-C and FLEX package

Package details
 on page 162



Automatic
boiling point
detection

RV 10 control

Motor type	brushless DC drive motor
Motor rating input	50 W
Speed range	20 – 280 rpm
Speed display	digital
Clockwise and counter-clockwise	yes
Soft start	yes
Head angle adjustable	0 to 45°
Stroke displacement	140 mm, motorized
Setting of lower end stop	60 mm, contact free
Vacuum controller	integrated

Dimensions (W x D x H)	530 x 410 x 430 mm
Weight	21.5 kg
Permissible ambient temperature	5 to 40 °C
Permissible relative moisture	80%
Protection class	IP 20
Voltage / Frequency	220 – 240 V / 50/60 Hz

RV 10 control V Ident. No. 0008037700*
 RV 10 control V-C Ident. No. 0008037900*
 RV 10 control FLEX Ident. No. 0008038100*
 RV 10 control V auto Ident. No. 0008037800
 RV 10 control V-C auto Ident. No. 0008038000
 RV 10 control FLEX auto Ident. No. 0008038200



RV 10 control auto

The enhanced RV 10 control is now equipped with our fully automated speed control pump N 920. Additionally, the RV 10 control auto detects the required level of vacuum pressure by detecting the boiling point of the solvent. This feature has some significant benefits over a valve-regulated system.

Advantages:

- > Increased solvent recovery performance up to 100%
- > Automatic boiling point detection
- > Speed controlled vacuum pump for precise vacuum level
- > Reduced noise level and wearing of pump components
- > Reduced process time and increased overall performance

Rotary Evaporators | Accessories



RV 10 / RV 8 accessories
Glassware

Ident. No.

RV 10.1 0003655300

Set of glassware, vertical

RV 10.10 0003755400

Set of glassware, vertical, coated



RV 10.2 0003755300

Set of glassware, diagonal

RV 10.20 0003755500

Set of glassware, diagonal, coated



Condensers

RV 10.3 0003741000

Vertical-intensive condenser, manifold

RV 10.30 0003741100

Vertical-intensive condenser, manifold, coated



RV 10.4 0003742000

Dry ice condenser

RV 10.40 0003742100

Dry ice condenser, coated



RV 10.5 0003743000

Vertical-condenser, reflux

RV 10.50 0003743100

Vertical-condenser, reflux, coated



RV 10.6 0003744000

Vertical-intensive condenser, reflux

RV 10.60 0003744100

Vertical-intensive condenser, reflux, coated



Evaporation cylinders

RV 10.400 0003738800

Evaporation cylinder, NS 29/32, 500 ml

RV 10.401 0003738900

Evaporation cylinder, NS 29/32, 1500 ml



Bump trap

RV 10.500 0003739200

Foam brake, NS 29/32



Distilling spider with distilling sleeves

RV 10.600 0003739400

Distilling spider, NS 29/32, 6 sleeves

RV 10.601 0003739500

Distilling spider, NS 29/32, 12 sleeves

RV 10.602 0003739600

Distilling spider, NS 29/32, 20 sleeves

RV 10.610 0003919400

Distilling sleeve, 20 ml

IKA®+

All evaporation flasks are available as a special temperature coated version (for usage at max. 180°C in a heating bath)



Distilling spider with 5 flasks

RV 10.606 0003740800

Distilling spider with 5 flasks, 50 ml

RV 10.607 0003740900

Distilling spider with 5 flasks, 100 ml



Evaporation flasks

RV 10.80 0003740100

Evaporation flask, NS 29/32, 50 ml

RV 10.81 0003740200

Evaporation flask, NS 29/32, 100 ml

RV 10.82 0003740300

Evaporation flask, NS 29/32, 250 ml

RV 10.83 0003740400

Evaporation flask, NS 29/32, 500 ml

RV 10.84 0003740500

Evaporation flask, NS 29/32, 1000 ml

RV 10.840 0004221400

Evaporation flask, NS 29/32, 1000 ml coated

RV 10.85 0003740600

Evaporation flask, NS 29/32, 2000 ml

RV 10.86 0003740700

Evaporation flask, NS 29/32, 3000 ml

Rotary Evaporators | Accessories



Receiving flasks

RV 10.100 0003742200

Receiving flask, KS 35/20, 100 ml

RV 10.101 0003742300

Receiving flask, KS 35/20, 250 ml

RV 10.102 0003742400

Receiving flask, KS 35/20, 500 ml

RV 10.103 0003742500

Receiving flask, KS 35/20, 1000 ml

RV 10.104 0003742600

Receiving flask, KS 35/20, 2000 ml

RV 10.105 0003742700

Receiving flask, KS 35/20, 3000 ml

RV 10.200 0003743200

Receiving flask, coated, KS 35/20, 100 ml

RV 10.201 0003743300

Receiving flask, coated, KS 35/20, 250 ml

RV 10.202 0003743400

Receiving flask, coated, KS 35/20, 500 ml

RV 10.203 0003743500

Receiving flask, coated, KS 35/20, 1000 ml



Powder flasks

RV 10.300 0003738200

Powder flask, NS 29/32, 500 ml

RV 10.301 0003738300

Powder flask, NS 29/32, 1000 ml

RV 10.302 0003738400

Powder flask, NS 29/32, 2000 ml



Vapor tubes, seals and other accessories

RV 10.70 0003812200

Vapor tube, NS 29/32

RV 10.74 0003971700

Vapor tube, short, NS 29/32



RV 10.8001 0003907000

Seal, PTFE, stainless steel



RV 10.3000 0003859000

Extension plate for use with RV 10.500 foam break and 3 l evaporation flask



HB 10 heating bath accessories

Ident. No.

HB 10.1 0003641800

Shield for heating bath HB 10



HB 10.2 0003641000

Protection cover for heating bath HB 10



Vacuum pumps

Ident. No.

MVP 10 basic 0003980000

For dry, oil-free applications in the low vacuum range

VCV 1 0020004850

Vacuum control valve manual

VCV 2 0020004893

Vacuum control valve digital

VSS 1 0020005194

Vacuum safety set



N 920 KT.29.18 0003919100

Membrane vacuum pump



SC 920 D400 0004583600

Vacuum pump



LVS 105T-10 ef 0004067800

Vacuum pump



RV 10 control accessories Vacuum pump valves

Ident. No.

① RV 10.4001 0003902600

Magnetic valve in-house vacuum

② RV 10.4002 0003880300

Magnetic valve laboratory vacuum

③ RV 10.4003 0003900200

Pump control including magnetic valve



Water valves

Ident. No.

④ RV 10.5001 0003902700

Choke water valve

⑤ RV 10.5002 0003903800

Filter

⑥ RV 10.5003 0003907100

Pressure regulating valve



RV 8 accessories

Ident. No.

RV 8.1 0004438500

Support Pole

RV 8.2 0025001342

Mechanical end stop for RV 8

Mechanical / Electronic Accessories

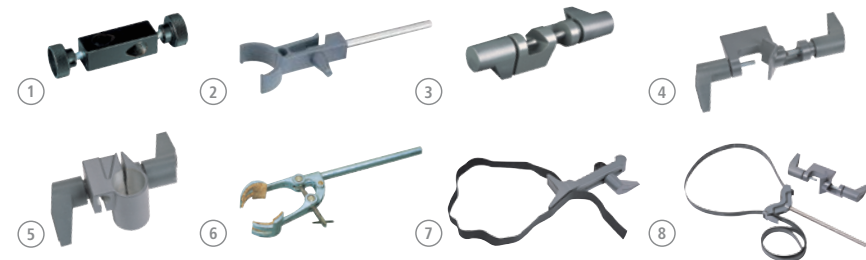

Mechanical accessories

	Ident. No.		Ident. No.
① H 44	0002437700	⑤ R 271	0002664000
Boss head clamp, clamping range Ø 10 – 11 mm		Boss head clamp, clamping range Ø 34 mm	
② R 200	0003372000	⑥ R 350	0001752900
Clamp for T 10 basic and R 104		Universal clamp	
③ R 182	0002657700	⑦ RH 3	0003008600
Boss head clamp, clamping range Ø 6 – 16 mm		Strap clamp for stand Ø 8 – 16 mm	
④ R 270	0002657800	⑧ RH 5	0003159000
Boss head clamp, clamping range Ø 25 – 36 mm		Strap clamp for stand Ø 8 – 16 mm	



Electronic accessories

	Ident. No.		Ident. No.
⑨ ALMEMO 2490	0004709300	⑩ DTM 12.10	0003127800
The ALMEMO 2490 is a universal measuring device with 2 measuring channels. Especially adopted for the requirements of either simple temperature measuring purposes or as an accessory for our lab reactors to measure and display temperature and/or pH.		Data cable, L2.5 m, 9 pins (F)	
		⑪ PT 100.23	0003122100
		Temperature sensor, stainless steel, Ø 3 mm, 250 mm length	
		⑫ PT 100.24	0003122200
		Temperature sensor, stainless steel, glass-coated, Ø 8 mm, 250 mm length	
		⑬ PT 100.25	0003122300
		Temperature sensor, stainless steel, Ø 6 mm, 255 mm length	

ALMEMO accessories

	Ident. No.
ALMEMO USB-cable	0004709400
USB-cable	
PC 1.2	0002616800
Adapter, 25 pins	
PH 225.1	0003122600
Electrode temperature sensor	

Lifts

⑭ LABLIFT m	0004022400
Manual scissors lift, set-up plate dimensions 170 x 230 mm, stroke 70 – 300 mm, max. dynamic load 7 kg	

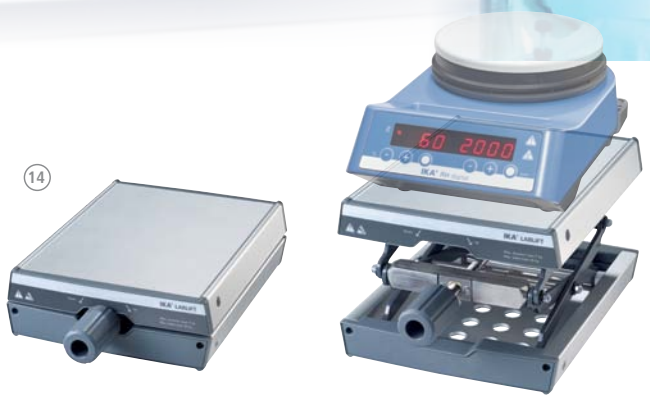

Mechanical Accessories

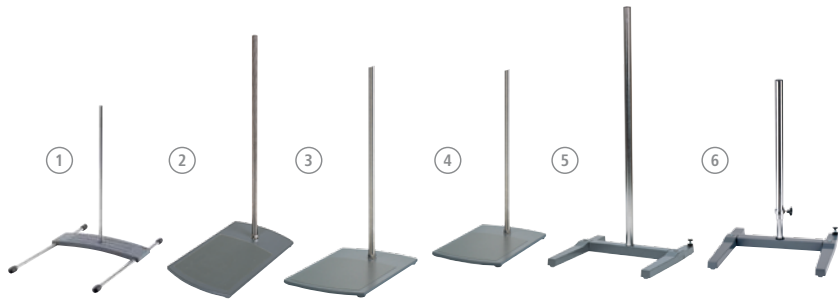
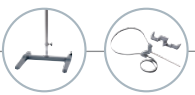

Stands

		Diameter of support rod	Dimensions (W x D)	Height
①	R 104 Stand Stand for T 10 basic, H 370 mm	10 mm	242 x 355 mm	370 mm
②	R 1825 Plate stand Plate stand, H 560 mm	16 mm	200 x 316 mm	560 mm
③	R 1826 Plate stand Plate stand, H 800 mm	16 mm	200 x 316 mm	800 mm
④	R 1827 Plate stand Plate stand, H 1000 mm	16 mm	200 x 316 mm	1000 mm
⑤	R 2722 H-Stand H-Stand, H 1010 mm	34 mm	460 x 420 mm	1010 mm
⑥	R 2723 Telescopic stand Telescopic stand, H 620 – 1010 mm	34 mm	460 x 420 mm	620 – 1010 mm
⑦	T 653 Telescopic stand Telescopic stand, H 1200 mm	48 mm	460 x 530 mm	1200 mm
⑧	R 474 Telescopic stand Telescopic stand, H 1200 mm	48 mm	460 x 530 mm	1200 mm
⑨	R 472 Floor stand Floor stand, H 2020 mm	–	80 x 80 mm	2020 mm
⑩	R 4765 Floor stand Floor stand, H 1014 – 1588 mm	–	764 x 870 mm	1500 mm
⑪	R 2850 Floor stand Floor stand, H 1900 mm	16 mm	980 x 875 mm	1921 mm

	Max. load	Stroke	Ident. No.
①	0.7 kg	–	0003386000
②	5 kg	–	0003160000
③	5 kg	–	0003160100
④	5 kg	–	0003160200
⑤	10 kg	–	0001412000
⑥	10 kg	390 mm	0001412100
⑦	–	500 – 1000 mm	0001608000
⑧	–	500 – 1000 mm	0001643000
⑨	–	980 – 1860 mm	0000738700
⑩	40 kg	465 mm	0030000149
⑪	8.5 kg	1800 mm	0020002900

Laboratory Reactors



IKA® lab reactors are the most unique systems when it comes to optimizing and reproducing chemical reaction, mixing, dispersing, and homogenization processes on a lab scale. The lab reactors can be individually customized to perform numerous tasks, including: production of cremes and lotions, the grinding and disintegrating of solids and fibers in liquids or polymers, etc. Single-walled or double-walled vessels made from borosilicate glass or stainless steel are available, each with or without bottom discharge valve.



reddot design award
winner 2013





German
Design Award
SPECIAL
MENTION

The modular, expandable laboratory reactor!

- > Wide range of applications
- > Manual adjustable safety circuit



LR 1000
basic

-  Digital Display
Digital display for monitoring of speed and temperature
-  C/T selector button for choosing between the counter or the timer function
-  Adjustable Safety Circuit
Adjustable safety circuit
-  Connections to attach a cooling source to the back of the unit

Laboratory Reactors



Technical data

Usable volume	400 – 1000 ml
Max. working temperature	120 °C
Nominal torque	3 Nm
Attainable vacuum	25 mbar
Max. viscosity	100,000 mPas
Speed range	10 – 150 rpm
Display	LED TFT
Heat output	1000 W
Heat control accuracy	± 1 K
Dimensions (W x D x H)	443 x 295 x 360 mm
Weight	16 kg
Permissible ambient temperature	5 – 40 °C
Permissible relative moisture	80%

LR 1000 basic | LR 1000 control

LR 1000 basic Package*

	Ident. No.
H 11 Main cable Euro plug	0001091500
LR 1000 basic base	0003600099
LR 1000.1 Reactor vessel	0003602000
LR 1000.61 Sensor receptacle	0004664400
PT 100.5 Temperature sensor	0002506800
LR 1000 basic Package	0008040100

LR 1000 control Package*

	Ident. No.
H 11 Main cable Euro plug	0001091500
LR 1000 control base	0003600099
LR 1000.3 Reactor vessel	0025001955
LR 1000.61 Sensor receptacle	0004664400
PT 100.5 Temperature sensor	0002506800
USB cable USB A-Micro B 2.0	0004335000
LR 1000 control Package	0008040200

* PT 100.5 included in the delivery for measuring the external temperature



pH
electrode

Possibility to connect
pH electrode

Integrated
weighing function

Integrated
weighing function

LR 1000
control

TFT
Display

Large, easy-to-read TFT display
for better image quality and
easy navigation

Torque trend measurement

indicates changes in viscosity
of the product

USB interface

USB interface to control and
document rheological changes
and other parameters using
labworldsoft® software and
for updating the firmware



reddot design award
winner 2013



German
Design Award
SPECIAL
MENTION

Patented
Integrated
weighing function

Laboratory Reactors | Packages

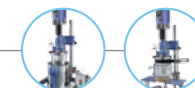

Modular design laboratory reactor for optimization and simulation of various chemical reactions as well as for mixing and homogenizing processes in a laboratory scale.

- > Suitable for vacuum operation
- > Seals in contact with the product are made of solvent- resp
- > Temperature-resistant perfluoroelastomer (FFPM)
- > Infinitely adjustable speed



Technical data	
Min. volume (anchor stirrer)	500 ml
Min. volume (T 25 digital)	800 ml
Max. volume	2000 ml
Max. working temperature	230 °C
Attainable vacuum	25 mbar
Max. viscosity (EUROSTAR 200 control P4)	150,000 mPas
Speed range (EUROSTAR 200 control P4)	0/4 – 530 rpm
Max. torque at stirring shaft (EUROSTAR 200 control P4)	660 Ncm
Height of telescopic stand	620 – 1010 mm
Dimensions (W x D x H)	460 x 430 x 1240 mm
	stainless steel (AISI 316L)
Metals in contact with medium	FFPM borosilicate glass 3.3



LR-2.ST Package 1*

Basic package with reactor cover (sealing material: FFPM) consisting of:

- > Stand system LR-2.ST
- > LR-2.SI Safety disconnection
- > EUROSTAR 200 control P4
- > LR 2000.11 Anchor stirrer with flow borings
- > LR 2.1 Single-walled reactor vessel
- > Temperature sensor H 68.55

Ident. No. 0009023600

LR-2.ST Package 2

Basic package with reactor cover (sealing material: FFPM) consisting of:

- > Stand system LR-2.ST
- > LR-2.SI Safety disconnection
- > EUROSTAR 200 control P4
- > LR 2000.11 Anchor stirrer with flow borings
- > LR 2000.1 Double-walled reactor vessel with quick-action connectors

Ident. No. 0009023700

LR-2.ST Package 3

Basic package with reactor cover (sealing material: FFPM) consisting of:

- > Stand system LR-2.ST
- > LR-2.SI Safety disconnection
- > EUROSTAR 200 control P4
- > LR 2000.11 Anchor stirrer with flow borings
- > LR 2000.2 Double-walled reactor vessel with quick-action connectors and bottom discharge valve

Ident. No. 0009023800

* HBR 4 Heating bath not included in the package

Laboratory Reactors | Accessories



LR 1000 accessories



Ident. No.	Ident. No.
1	LR 1000.1
0003602000	Reactor vessel, 1000 ml, FFKM Sealings, 4 connectors
2	LR 1000.3
0025001955	Reactor vessel, 1000 ml, FFKM Sealings, 6 connectors
LR 1000.10	0004663100
Anchor stirrer with PEEK scrapers	
LR 1000.11	0004663000
Anchor stirrer, stainless steel	
LR 1000.20	0004663200
Flow breaker / baffle, stainless steel	



LR 1000.41	0004664300
Shaft receptacle to install the dispersing elements S 25 KV	



LR 1000.61	0004664400
Sensor receptacle to install the temperature sensors PT 100.25 and PT 100.5	

LR 1000.64	0004663300
pH electrode	

LR 1000.65	0004663400
pH electrode receptacle	

LR-2.ST accessories

Ident. No.	Ident. No.
3	LR 2000.10
0002508400	Anchor stirrer with PTFE scraper
4	LR 2000.11
0002509500	Anchor stirrer, stainless steel
5	LR 2000.20
0002508500	Flow breaker / baffle, stainless steel
6	LR 2.1
0003070000	Reactor vessel, single-walled, 2000 ml
7	LR 2000.1
0002508300	Reactor vessel, double-walled, 2000 ml
LR 2000.2	0002509600
Reactor vessel, double-walled, 2000 ml with bottom drain	
8	LR 2000.40
0002509200	Shaft receptacle to install the dispersing elements S 25 KV
9	LR 2000.60
0002509300	Sensor receptacle to install the temperature sensors PT 100.25 and PT 100.5

LR 2000.65	0003172600
pH measuring sensor receptacle	

PH 225.1*	0003122600
pH electrode with temperature sensor	

DTM 12.15*	0003128300
Adapter cable for pH electrode LR-2.ST	

LR-2.SP	0003326400
Splinter shield	

3



4



5



6



7



8



9



10



11



12



13

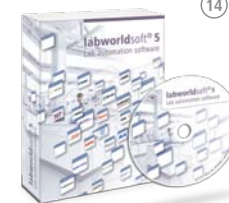

14

LR-2.ST accessories

Ident. No.	Ident. No.
LT 5.20	0002606700
Hose, insulated, stainless steel, Ø 10 mm, 150 mm, 2 pcs.	
LT 5.21	0020000988
Hose, insulated, PTFE, Ø 13 mm, 150 mm, 2 pcs.	
LT 5.24	0002578100
Hose adapter	
LT 5.25	0020000878
Lock Coupling	
LT 5.26	0020000879
Lock Adapter	
LT 5.27	0020000880
Hose Adapter	

Common accessories

Ident. No.	Ident. No.
10	T 25 digital
0003725000	Dispenser
11	S 25 KV – 25 F
0002404000	Dispersing element
12	S 25 KV – 25 G
0002466900	Dispersing element
13	S 25 KV – 18 G
0002348000	Dispersing element
14	labworldsoft®
0004720000	Laboratory software

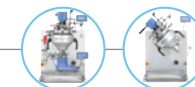

magic PLANT



The ideal small laboratory plant for perfect mixing and homogenizing of liquid to pasty products.

Effective dispersing and homogenizing. In connection with the IKA® magicLAB®, the magic PLANT is specially adapted to the requirements of batch plants.

Efficient but gentle mixing and drying of all free flowing solids, including products with different bulk densities and particle sizes.



The most versatile laboratory reactor

The IKA® magic PLANT is an ideal laboratory scale process plant. This system is used for batch-wise mixing, homogenizing, emulsifying, in addition to forming sample suspensions for capacities of up to 2 liters. Whether it is involved with the manufacturing of liquids, pastes or powders - the magic PLANT delivers, enabling a seamless transition from product development to production.

Technical data	magic PLANT basic	magic PLANT inline	magic PLANT powder
Max. admissible temperature	150 °C	150 °C	150 °C
Working pressure range	-1 up to 2.5 bar	-1 up to 2.5 bar	-1 up to 2.5 bar
Useful volume	2 l	2 l	2 l
Stirring tool	anchor or propeller	propeller	spiral agitator
Speed range	0 – 350 rpm 0 – 2000 rpm	0 – 350 rpm 0 – 2000 rpm	0 – 350 rpm
	Ident. No. U105363	Ident. No. U107703	Ident. No. U107159

magic PLANT



Modular design



Higher viscosity products processible



Tiltable vessel



Software



IKA®'s software labworldsoft® enables the networking of up to 64 laboratory devices which can be controlled simultaneously via one PC. Not only IKA® products, but also other manufacturers' laboratory devices can be integrated using labworldsoft®. CalWin represents the newest generation of professional software for all IKA® calorimeters. It offers numerous functions for monitoring and evaluating results.

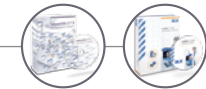

Advanced software with an innovative visual approach to lab automation

labworldsoft® is a multi-purpose software program for measuring, controlling and regulating laboratory devices. It can network up to 64 devices simultaneously via one PC, thus making the automation of your laboratory experiments and processes much more easy and efficient. It not only integrates IKA® laboratory devices but also supports devices from other manufacturers.



labworldsoft®

Hardware and software requirements

Pentium processor with at least 16 MB RAM, 8 MB free hard disc memory, VGA-Display: monochrome with at least 16 levels of gray or color, Windows 95/98/2000/NT/ME/XP/7 and com ports can be upgraded for special needs.

Ident. No. 0004720000



C 6040 CalWin

Hardware and software requirements

Windows XP (SP2), Windows Vista, Windows 7, Windows 8 and at least one free USB or RS 232 (9 pin Sub-D (M)) serial interface. Processor with min. 1.6 GHz (single core-Processor); 2 GB RAM; 2.5 GB free hard-disc space; DVD-ROM-drive.

Ident. No. 0004040500

IKA+

Try it for yourself!
Get your free, fully functional, 30-day trial version Download at:
www.ika.com

Software | Accessories



Manufacturers with interface devices compatible to labworldsoft®



Accessories

PCI 8.2 Plug-in card

To be integrated into the PC – used for connecting up to 8 devices simultaneously.

Ident. No. 0008017500

PC 4.1 RS 232 Server

Can control up to 4 lab units through the ethernet. The server supports 4 RS 232 ports with a 10/100 mbps ethernet interface by TCP/IP. The server can be set-up through the ethernet and works as a transparent serial COM-Port without restrictions of platform and distance.

Ident. No. 0003192000



① Expert Key 100 eco 0020005486
Data collection system for laboratories

② Expert Key 100 pro 0020005485
Data collection system for industrie

Multi Power Switch 0020003454
Adapter for Expert Key

RV 10 A 1 0020004315
Adapter LEMO for Expert Key

PT 1000 A 1 0020004316
Adapter DIN 6 for Expert Key

PT 100.10 A 1 0020004317
Adapter DIN 5 for Expert Key

Cable

Cable	Length	Ident. No.
PC 1.1 Cable	3 m	0002616700
PC 1.5 Cable	2.5 m	0002756000
PC 2.1 Cable	5 m	0002700700
PC 2.3 Cable	3 m	0003036200
DTM 12.10 Cable	2.5 m	0003127800

Adapter

PC 1.2 Adapter	–	0002616800
PC 1.4 Adapter	–	0002755900
PC 2.2 Adapter	–	0002753200
PC 5.1 Adapter	–	0002621500

* For more information on cables and adapters, please visit our website: www.ika.com/products

Calorimeters



IKA® oxygen bomb calorimeters are the market leaders when it comes to determining the calorific values of liquid and solid samples. The selection of IKA® oxygen bomb calorimeters is optimally geared towards various different demands. Functionality, safety, and longevity were the main goals in the development of IKA®'s oxygen bomb calorimeters.



The world's smallest calorimeter ever!

- > Represents the smallest static jacket calorimeter in the world
- > combined modern technology with unique automation

C 1



The traditional heavy screw threaded bomb has been replaced by a light combustion chamber



Automatic oxygen filling, venting and flushing



Automatic ignition with fixed ignition wire as well as ignition energy determination for each experiment



Automatic water filling and draining



Calorimeters



Software provides control chart view and correction calculation of globally used standards



RFID technology used for decomposition vessel identification



Easy bomb preparation due to new "turned around" crucible holder technology



Technical data

Maximum energy input	40,000 J
Resolution of the temperature sensor	0.0001
Power ON-time	100 %
Operating oxygen pressure	30 bar
Measuring modes / Measurements per hour	Static jacket (Regnault Pfaundler) 4
Start temperature settings	2 possible settings: 22 °C or 30 °C
RSD (using NIST benzoic acid 39j)	Static jacket (Regnault Pfaundler) 0.15 %
Number of decomposition vessel per unit	up to 2

C 1

C 1 Ident. No. 0003825000
C 1 Package 1/10 Ident. No. 0010001045

C 6000 isoperibol

Maximum energy input	40,000 J
Resolution of the temperature sensor	0.0001
Power ON-time	100 %
Operating oxygen pressure	30 bar
Measuring modes / Measurements per hour	Isoperibol (Regnault Pfaundler) 4 Dynamic 6
Start temperature settings	3 possible settings: 22 °C, 25 °C, 30 °C
RSD (using NIST benzoic acid 39j)	Isoperibol (Regnault Pfaundler) 0.05 % Dynamic 0.15 %
Number of decomposition vessel per unit	up to 4

Package 1/10 Ident. No. 0010001048
Package 1/12 Ident. No. 0010001049
Package 2/10 Ident. No. 0008804700
Package 2/12 Ident. No. 0008804800

C 6000 global standards

Maximum energy input	40,000 J
Resolution of the temperature sensor	0.0001
Power ON-time	100 %
Operating oxygen pressure	30 bar
Measuring modes / Measurements per hour	Adiabatic 5 Isoperibol (Regnault Pfaundler) 4 Dynamic 6
Start temperature settings	3 possible settings: 22 °C, 25 °C, 30 °C
RSD (using NIST benzoic acid 39j)	Adiabatic 0.05 % Isoperibol (Regnault Pfaundler) 0.05 % Dynamic 0.15 %
Number of decomposition vessel per unit	up to 4

Package 1/10 Ident. No. 0010001046
Package 1/12 Ident. No. 0010001047
Package 2/10 Ident. No. 0008804300
Package 2/12 Ident. No. 0008804400

Package details on page 164



Calorimeters



	C 200	C 2000
Technical data		
Maximum energy input	40,000 J	40,000 J
Resolution of the temperature sensor	0.0001	0.0001
Power ON-time	continuous operation	continuous operation
Operating oxygen pressure	–	30 bar
Measuring modes / Measurements per hour	Isoperibol 3 Dynamic 5 Manual(Isoperibol) 3 Time-controlled 4	Isoperibol 3 Dynamic 6
Start temperature settings	18 – 25 °C	2 possible settings: 25 °C or 30 °C
RSD (using NIST benzoic acid 39j)	Isoperibol 0.1 % Dynamic 0.1 % Manual (Isoperibol) 0.1 % Time-controlled 0.1 %	Isoperibol 0.05 % Dynamic 0.1 %
Number of decomposition vessel per unit	up to 4	up to 4
	C 200 Ident. No. 0008802500 C 200 h Ident. No. 0008803700	basic Version 1 Ident. No. 0008801800 basic Version 2 Ident. No. 0008801900

	C 5000	C 7000
Maximum energy input	40,000 J	30,000 J
Resolution of the temperature sensor	0.0001	0.0001
Power ON-time	continuous operation	continuous operation
Operating oxygen pressure	30 bar	30 bar
Measuring modes / Measurements per hour	Adiabatic 4 Isoperibol 3 Dynamic 6	double dry
Start temperature settings	Package 1: 22 °C / Package 2: 25 °C	12 – 30 °C (cooling water)
RSD	Adiabatic 0.05 % Isoperibol 0.05 % Dynamic 0.1 %	double dry 0.2 % – 0.5 %
Number of decomposition vessel per unit	up to 4	up to 4
	Package 1/10 Ident. No. 0008803000 Package 1/12 Ident. No. 0008803300 Package 2/10 Ident. No. 0008803200 Package 2/12 Ident. No. 0008803400	basic set 1 Ident. No. 0008800900 basic set 2 Ident. No. 0008801400

Calorimeters | Accessories & consumables



IKA® +

The halogen resistant decomposition vessels C 5012, C 6012 and C 7012 are equipped with a catalytically active surface, which enhances the on-going reactions during the combustion. As a result, higher recovery rates for halogens and sulfur are achieved.

C 1 Accessories and consumables

	Ident. No.
C 1.1012	0004500700
Organizer	
C 1.30	0004500900
Venting station	
C 1.10	0004500300
Combustion chamber	
C 1.101	0004502200
Set of spare parts, approx. 1000 experiments	

C 200 accessories

	Ident. No.
C 248	0003520000
Oxygen station	
C 200.1	0003548900
Measuring cup, 2000 ml	
C 200.2	0004028800
Conversion kit for C 5012	

C 6000 Accessories and consumables

	Ident. No.
C 6010	0003770000
Decomposition vessel, standard	
C 6012	0004504000
Decomposition vessel, halogen resistant	
C 6030	0004504100
Venting station	
C 60.1012	0004504200
Organizer	
C 6000.10	0004504300
Set of spare parts, approx. 1000 experiments	
C 6000.12	0004504400
Set of spare parts, approx. 1000 experiments	

C 1 and C 6000 consumables

	Ident. No.
C 1.50	0004500600
Dot matrix printer	
① C 1.103	0004579300
Ignition wire, standard, Kantal, 5 pcs.	
② C 1.123	0004500200
Ignition wire, platinum, 2 pcs.	

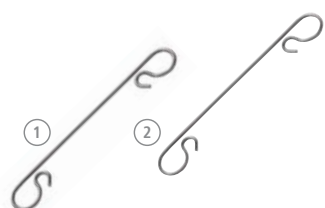

Accessories for all Calorimeters

	Ident. No.
C 27	0004579700
Calorimeter preparation set	
C 29	L004944
Pressure gauge, oxygen	
C 21	0001605300
Pelleting press	
C 5010.8	0004579800
Crucible holder, small	
C 5010.5	0003055900
Crucible holder, big	

C 200, C 2000, C 5000 accessories

	Ident. No.
C 5010	0007114000
Decomposition vessel, standard	
C 5012	0007215000
Decomposition vessel, halogen resistant	
C 5030	0007198000
Venting station	
C 5010.4	0003016900
Attachment for combustible crucible C 14	
C 26	0008804000
Prep stand	

C 2000, C 5000, C 6000 accessories

	Ident. No.
C 5020	0007145000
Sample rack	

C 1, C 2000, C 6000 accessories

	Ident. No.
C 25	0003197200
Pressure regulating valve	

C 7000 accessories

	Ident. No.
C 7000	0003008000
Measurement cell	
C 7010	0003015000
Decomposition vessel, standard	
C 7012	0003017000
Decomposition vessel, halogen resistant	
C 7002	0007011000
Cooling system	
C 48	0001560000
Oxygen station	
C 7030	0003013300
Venting station	
C 7010.8	0007095000
Venting handle	
C 5010.4	0003016900
Attachment for combustible crucible C 14	
C 5010.5	0003055900
Crucible holder, big	

Calorimeters | Accessories & consumables



Consumables for all calorimeters

	Ident. No.
3 C 1.104	0020003598
Water bath additive, 30 ml	
4 C 710.4	0001483700
Cotton thread, cut to length, 500 pcs.	
C 710.8	0004579900
Cotton thread, cut to length, thick, 500 pcs.	
5 C 4	0001695500
Quartz dish	
6 C 5	0001749500
Set of VA combustion crucibles, 25 pcs.	
7 C 6	0000355100
Quartz dish, big	
8 C 710.2	0001483500
Set of VA combustion crucibles, 25 pcs.	
9 C 9	0000749900
Gelatine capsules, 100 pcs.	
10 C 10	0000750000
Acetobutyrate capsules, 100 pcs.	

C 12	0002201400
Combustion bags, 40 x 35 mm, 100 pcs	
C 12 A	0002201500
Combustion bags, 70 x 40 mm, 100 pcs	
C 15	0003131100
Paraffin strips, 45 x 3 mm, 600 pcs.	
C 16	0003801100
Parafilm, 1000 x 50 mm	
11 C 17	0003801200
Paraffin, liquid, 30 ml	
12 C 43	0000750600
Benzoic acid, NIST 39j, 30 g	
13 C 723	0003243000
Benzoic acid, blister package, 0.5 g, 50 pcs.	
C 723 Big pack	0003717400
Benzoic acid, blister package, 0.5 g, 450 pcs.	
14 AOD 1.11	0003044000
Control standard, 50 ml, for Sulfur and chlorine	
15 AOD 1.12	0003080200
Control standard, 50 ml, for fluorine and bromine	

C 200, C 2000, C 5000 and C 7000 consumables	Ident. No.
C 5010.3	0007122800
Ignition wire, spare, 5 pcs.	
C 5012.3	0002994900
Ignition wire, platinum, 2 pcs.	
C 14	0007224500
Combustible crucible, 100 pcs.	

Calorimeter instructions

Instruction on the IKA® Calorimeter system

Decomposition system

	Ident. No.
AOD 1	0008801300
Decomposition system	

Decomposition accessories

	Ident. No.
AOD 1.1	0003303000
Decomposition vessel	
AOD 1.2	0003348000
External ignition unit	
AOD 1.3	0003308000
Protection device	
AOD 1.13	0003348100
Remote ignition head	



C 6040 CalWin

Hardware and software requirements

Windows XP (SP2), Windows Vista, Windows 7, Windows 8 and at least one free USB or RS 232 (9 pin Sub-D (M)) serial interface. Processor with min. 1.6 GHz (single core-Processor); 2 GB RAM; 2.5 GB free hard-disc space; DVD-ROM-drive.

Ident. No. 0004040500

IKA® Packages

Package name / Package description	Ident No.
C-MAG HS 7 Package	0009015900
C-MAG HS 7	0003581200
ETS-D5 Electronic contact thermometer	0003378000
H 38 Holding rod	0003547700
H 44 Boss head clamp	0002437700
H 16 V Support rod	0001545100



Package name / Package description	Ident No.
KS 130 basic Package	0009019000
KS 130 basic	0002980000
AS 130.3 Dish attachment	0003120000
STICKMAX universal adhesive mat	0003920000
KS 130 control NOL Package	0009025500
KS 130 control NOL	0004278200
AS 130.3 Dish attachment	0003120000
STICKMAX universal adhesive mat	0003920000
KS 260 basic Package	0009019200
KS 260 basic	0002980200
AS 260.3 Dish attachment	0003120600
2 x STICKMAX universal adhesive mat	0003920000
KS 260 control NOL Package	0009025600
KS 260 control NOL	0004278400
AS 260.3 Dish attachment	0003120600
2 x STICKMAX universal adhesive mat	0003920000

Package name / Package description	Ident No.
RW 28 digital Package	0009023200
RW 28 digital (drive)	0005040000
R 2723 Telescopic stand	0001412100
R 1385 Propeller stirrer	0000477700
R 271 Boss head clamp	0002664000
RW 47 digital Package	0009023300
RW 47 digital (drive)	0004050000
R 2302 Propeller stirrer	0000739000
R 474 Telescopic stand	0001643000



Package name / Package description	Ident No.
T 10 standard PCR kit	0004095500
S 10 D - 7 G - KS - 65 Dispersing tool	0003380600
S 10 D - 7 G - KS - 110 Dispersing tool	0003380700
Disposable Generator 7 x 65 mm (12 pcs.)	0003380612
R 200 clamp	0003372000
T 18 digital Package	0009022800
T 18 digital	0003720000
S 18 N - 19 G Dispersing tool	000L004640
T 65 basic Package	0009023400
T 65 basic	0004023500
S 65 KG - HH - G 65 G Dispersing tool	0008005500
T 653 Telescopic stand	0001608000
T 65 digital Package	0009023500
T 65 digital	0004234500
S 65 KG - HH - G 65 G Dispersing tool	0008005500
T 653 Telescopic stand	0001608000

Magnetic stirrers
with heating
page 10



Mechanical
Overhead stirrers
page 34



T-series ULTRA-TURRAX®
Dispersers
page 68



Shakers
page 50



IKA® Packages

1

Package name / Package description	Ident. No.
Open heating bath circulators	
ICC basic eco 8*	0008034900
ICC control eco 8**	0008035300
BS.ICC	0020003077
IB eco 8 Bath vessel, plastic	0004248100
ICC basic eco 18*	0008035000
ICC control eco 18**	0008035400
BL.ICC	0020003078
IB eco 18 Bath vessel, plastic	0004248200
ICC basic pro 9*	0009035100
ICC control pro 9**	0008035100
BS.ICC	0020003077
IB pro 9 Bath vessel, stainless steel	0004248500
ICC basic pro 12*	0010000414
ICC control pro 12**	0010000415
BL.ICC	0020003078
IB pro 12 Bath vessel, stainless steel	0004248600
ICC basic pro 20*	0008035200
ICC control pro 20**	0008035600
CL.ICC	0004471600
IB pro 20 Bath vessel, stainless steel	0004577500

* ICC basic included in delivery

** ICC control included in delivery

3

Package name / Package description	Ident. No.
Open heating bath circulators with cover	
IC basic eco 18 c*	0008036600
IC control eco 18 c**	0008037000
IB eco 18 Bath vessel, plastic	0004248200
CL.IC Cover	0004471800
IC basic pro 12 c*	0008039900
IC control pro 12 c**	0008040000
IB pro 12 Bath vessel, stainless steel	0004577500
CM.IC Cover	0004577600
IC basic pro 20 c*	0008036800
IC control pro 20 c**	0008037200
IB pro 20 Bath vessel, stainless steel	0004248600
CL.IC Cover	0004471800

* IC basic included in delivery

** IC control included in delivery. PT 100.30 Temperature Sensor, CC 1 Cooling Coil, and BS.IC Bridge are all included in the delivery for both IC basic | control Packages with cover

Thermostats
page 110



2

Package name / Package description	Ident. No.
Open heating bath circulators with cover	
ICC basic eco 8 c*	0008035700
ICC control eco 8 c**	0008036100
BS.ICC	0020003077
CS.ICC	0004471500
IB eco 8 Bath vessel, plastic	0004248100
ICC basic eco 18 c*	0008035800
ICC control eco 18 c**	0008036200
BL.ICC	0020003078
CL.ICC	0004471600
IB eco 18 Bath vessel, plastic	0004248200
ICC basic pro 9 c*	0008035900
ICC control pro 9 c**	0008036300
BS.ICC	0020003077
CS.ICC	0004471500
IB pro 9 Bath vessel, stainless steel	0004248500
ICC basic pro 12 c*	0010000416
ICC control pro 12 c**	0010000417
BL.ICC	0020003078
CM.ICC	0025000290
IB pro 12 Bath vessel, stainless steel	0004248600
ICC basic pro 20 c*	0008036000
ICC control pro 20 c**	0008036400
BL.ICC	0020003078
CL.ICC	0004471600
IB pro 20 Bath vessel, stainless steel	0004577500

* ICC basic included in delivery

** ICC control included in delivery
PT 100.30 Temperature sensor, CC2 Cooling Coil, and PCS.ICC Pump connection are all included in the delivery for ICC control Packages with cover



Thermostats
page 110



IKA® Packages

Package name / Package description	Ident No.
RV 8 V	0008033800
RV 8	0004057099
HB 10 heating bath	0004068099
RV 10.1 Set of glassware, vertical	0003655300
RV 10.70 Vapor tube, NS 29/32	0003812200
RV 8 V-C	0008034200
RV 8	0004057099
HB 10 heating bath	0004068099
RV 10.10 Set of glassware, vertical, coated	0003755400
RV 10.70 Vapor tube, NS 29/32	0003812200
RV 8 FLEX	0008033400
RV 8	0004057099
HB 10 heating bath, incl. Woulff bottle	0004068099
RV 05.10 Balljoint clamp	0000736600
RV 10.88 Clamp, NS 29	0003683300
RV 10.70 Vapor tube, NS 29/32	0003812200
RV 10 digital V	0008040300
RV 10 digital	0003550099
HB 10 heating bath	0004068099
RV 10.1 Set of glassware, vertical	0003655300
RV 10.70 Vapor tube, NS 29/32	0003812200
RV 10 digital V-C	0008040400
RV 10 digital	0003550099
HB 10 heating bath	0004068099
RV 10.10 Set of glassware, vertical, coated	0003755400
RV 10.70 Vapor tube, NS 29/32	0003812200
RV 10 digital FLEX	0008040500
RV 10 digital	0003550099
HB 10 heating bath, incl. Woulff bottle	0004068099
RV 05.10 Balljoint clamp	0000736600
RV 10.88 Clamp, NS 29	0003683300
RV 10.70 Vapor tube, NS 29/32	0003812200



RV 8



RV 10 digital

Rotary Evaporators
page 122



Package name / Package description	Ident No.
RV 10 control V	0008037700
RV 10 control	0004411099
HB 10 heating bath	0004068099
RV 10.1 Set of glassware, vertical	0003655300
RV 10.70 Vapor tube, NS 29/32	0003812200
RV 10.4002 Magnetic valve laboratory vacuum	0003880300
RV 10 control V-C	0008037900
RV 10 control	0004411099
HB 10 heating bath	0004068099
RV 10.10 Set of glassware, vertical, coated	0003755400
RV 10.70 Vapor tube, NS 29/32	0003812200
RV 10.4002 Magnetic valve laboratory vacuum	0003880300
RV 10 control FLEX	0008038100
RV 10 control	0004411099
HB 10 heating bath, incl. Woulff bottle	0004068099
RV 05.10 Balljoint clamp	0000736600
RV 10.88 Clamp, NS 29	0003683300
RV 10.70 Vapor tube, NS 29/32	0003812200
RV 10.4002 Magnetic valve laboratory vacuum	0003880300
RV 10 control V auto	0008037800
RV 10 control	0004411099
Pump with analog connection	0004406000
HB 10 heating bath	0004068099
RV 10.1 Set of glassware, vertical	0003655300
RV 10.70 Vapor tube, NS 29/32	0003812200
RV 10 control V-C auto	0008038000
RV 10 control	0004411099
Pump with analog connection	0004406000
HB 10 heating bath	0004068099
RV 10.10 Set of glassware, vertical, coated	0003755400
RV 10.70 Vapor tube, NS 29/32	0003812200
RV 10 control FLEX auto	0008038200
RV 10 control	0004411099
Pump with analog connection	0004406000
HB 10 heating bath, incl. Woulff bottle	0004068099
RV 05.10 Balljoint clamp	0000736600
RV 10.88 Clamp, NS 29	0003683300
RV 10.70 Vapor tube, NS 29/32	0003812200



RV 10 control auto

Rotary Evaporators
page 124



IKA® Packages

Package name / Package description	Ident. No.
C 1 Package 1/10	0010001045
C 1	0003825000
RC 2 basic refrigerated circulator	0004171000
C 6000 global standards Package 1/10	0010001046
C 6000 global standards	0003780000
C 6010 Decomposition vessel, standard	0003770000
RC 2 basic refrigerated circulator	0004171000
C 6000 global standards Package 1/12	0010001047
C 6000 global standards	0003780000
C 6012 Decomposition vessel, halogen resistant	0004504000
RC 2 basic refrigerated circulator	0004171000
C 6000 global standards Package 2/10	0008804300
C 6000 global standards	0003780000
C 6010 Decomposition vessel, standard	0003770000
C 6000 global standards Package 2/12	0008804400
C 6000 global standards	0003780000
C 6012 Decomposition vessel, halogen resistant	0004504000
C 6000 isoperibol Package 1/10	0010001048
C 6000 isoperibol	0004025000
C 6010 Decomposition vessel, standard	0003770000
RC 2 basic refrigerated circulator	0004171000
C 6000 isoperibol Package 1/12	0010001049
C 6000 isoperibol	0004025000
C 6012 Decomposition vessel, halogen resistant	0004504000
RC 2 basic refrigerated circulator	0004171000
C 6000 isoperibol Package 2/10	0008804700
C 6000 isoperibol	0004025000
C 6010 Decomposition vessel, standard	0003770000
C 6000 isoperibol Package 2/12	0008804800
C 6000 isoperibol	0004025000
C 6012 Decomposition vessel, halogen resistant	0004504000



C 1



C 6000



C 200



C 2000



C 5000

Package name / Package description	Ident. No.
C 200 h	0008803700
C 200	0003385000
C 200.2 Conversion set for C 5012	0004028800
C 248 Oxygen station	0003520000
C 5012 Decomposition vessel, halogen resistant	0007215000
C 2000 basic Version 1	0008801800
C 2000 basic	0003180000
C 5010 Decomposition vessel, standard	0007114000
C 2000 basic Version 2	0008801900
C 2000 basic	0003180000
C 5012 Decomposition vessel, halogen resistant	0007215000
C 5000 control Package 1/10	0008803000
C 5000 control	0003048000
C 5001 Cooling system	0007066000
C 5003 Measurement cell	0003595000
C 5010 Decomposition vessel, standard	0007114000
C 5000 control Package 1/12	0008803300
C 5000 control	0003048000
C 5001 Cooling system	0007066000
C 5003 Measurement cell	0003595000
C 5012 Decomposition vessel, halogen resistant	0007215000
C 5000 control Package 2/10	0008803200
C 5000 control	0003048000
C 5003 Measurement cell	0003595000
C 5004 Heat exchanger	0007216500
C 5010 Decomposition vessel, standard	0007114000
C 5000 control Package 2/12	0008803400
C 5000 control	0003048000
C 5003 Measurement cell	0003595000
C 5004 Heat exchanger	0007216500
C 5012 Decomposition vessel, halogen resistant	0007215000

Calorimeters
page 150



Calorimeters
page 152



IKA® offers more

IKA®
Online

Application
Support

Worldwide
service
network

Customizing
Center

IKA® Online

Get up-to-date information about products, new innovations, videos, photos, press releases and much more

www.ika.com
Visit Now!

Customizing Center

It is important that IKA® products work for your application. We are introducing a new program: product solutions tailored to your needs.

Should you not find the appropriate device in our standard product range, please send us your requested specifications through the online form. Our team will determine its feasibility and offer a solution to you.

Please visit www.ika.com/customizingcenter to review already implemented product modifications.



Worldwide service network – direct contact in your region

Our dedicated team of engineers provides comprehensive worldwide technical service. Please feel free to contact IKA® directly or your dealer in case of any service questions.

For spare parts IKA® guarantees 10 years of availability. In the event of an equipment malfunction or technical questions regarding devices, maintenance and spare parts, please call us at **00 8000 4524357** (00 8000 IKAHELP) or send an email to service@ika.com

IKA® Application Support

Our Application Center spans 400 sqm and offers modern facilities for presenting and testing lab devices and processes. This brings us even closer to our customers and improves our service. Here, prospective buyers and customers can test processes that involve stirring, shaking, dispersing, grinding, heating, analyzing and distilling.

Call us at **00 8000 4524357** (00 8000 IKAHELP) or send an email to applicationsupport@ika.de or visit our website at www.ika.com/applicationsupport

IKA®+

Ordering made easy

For more information about our products and to place your order, please visit:

www.ika.com

201504_POV 2015_A5_Brochure_EN_IWS_wop

IKA®-Werke GmbH & Co. KG

Janke & Kunkel-Str. 10
79219 Staufen
Germany

Tel. +49 7633 831-0
Fax +49 7633 831-98

sales@ika.de
www.ika.com



[IKAworlwide](#) | [#lookattheblue](#)

IKA® Worldwide

USA

IKA®-Works, Inc.
Phone: +1 910 452-7059
sales@ika.net

China

IKA® Works Guangzhou
Phone: +86 20 8222 1771
info@ika.cn

Malaysia

IKA® Works (Asia) Sdn Bhd
Phone: +60 3 6099-5666
sales.lab@ika.my

India

IKA® India Private Limited
Phone: +91 80 2625 3900
info@ika.in

Japan

IKA® Japan K.K.
Phone: +81 6 6730 6781
info_japan@ika.ne.jp

Brasil

IKA® do Brasil
Phone: +55 19 3772-9600
info@ika.net.br

Korea

IKA® Korea. Ltd.
Phone: +82 2 2136 6800
info@ika.kr